

The **fnc4000(D,X or A)** are all control devices that can plug directly into any of the range of connection units or a 7-pole single socket outlet. Working with at least a plug-in sensor head or together with a switch, the device will control the connected mains rated luminaires ON, OFF and DIM up or down. The exact operation will largely depend on which of the input devices are connected. Note that any connected switch or sensor head will be operating at ELV.

Three products are available:

fnc4000D : DSI digital dimmable ballasts.

fnc4000X: DALI digital dimmable ballasts.

fnc4000A : Analogue ballasts 0-10V.

Please ensure the correct product is selected for the type of ballast being used as incorrect connection may damage the controller.

This product should only be installed by a qualified electrician.

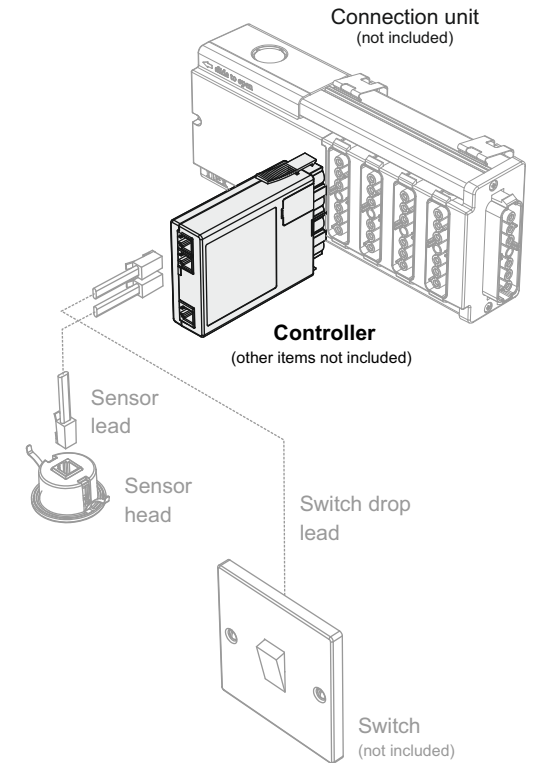

Configuring the **fnc4000(D,X or A)** controller

Prise open lid 'C' using a screw driver. Position link as required.

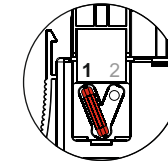
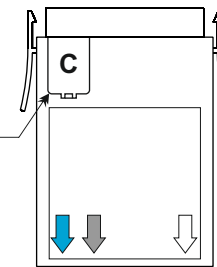

Link in position 1
Lights can remain ON during an emergency test. Wire connection unit as shown on the back page.

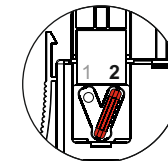

Link in position 2
Lights will switch OFF during an emergency test. Wire connection unit as shown on the back page.

Supply Voltage :Nominal 230V~ 50Hz	IP Rating :IP20
Type :Class 2	Compliance :2014/35/EU
Material :PA6 UL94 V-0 rated, Non-halogen	Max No. DALI :up to 25 drivers
Operating range :-10°C to 40°C	
Switched Load :6A	
Peak Inrush :120A (duration <20mS)	



flex7 Limited, Ruscombe Business Park, Ruscombe Lane, Twyford, Berkshire RG10 9JW, UK
 Telephone: +44 (0) 20 8580 1066 Fax: +44 (0) 20 8580 1062
 Website: www.flex7.co.uk Email: info@flex7.co.uk
 Leaflet reference number: 22/014 issue 8 04/03/2025



Using a fnc4000(D,X or A) controller with a sensor head only

* Refer to leaflet *Networking Sensors*, leaflet number 17/245.

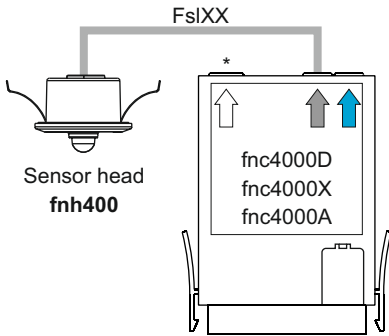

Operation

Occupancy detection: Lights will switch ON whenever there is occupancy detected by the sensor head. When occupancy is no longer detected, lights will switch OFF after a pre-selected *time-out* period (default 20 minutes).

Daylight linking: While lights are ON due to occupancy their light output will adjust to compensate for any changes in ambient light in order to maintain a constant light level under the sensor head - the *target level*.

Note: Alternative operational options not necessarily shown above are available using the **frc/set** setup remote control. Full instructions for setting up the sensor are supplied with the sensor head and the **frc/set** remote control - both ordered separately.

Using fnc4000(D,X or A) controller with a sensor head & an override switch

* Refer to leaflet *Networking Sensors*, leaflet number 17/245.

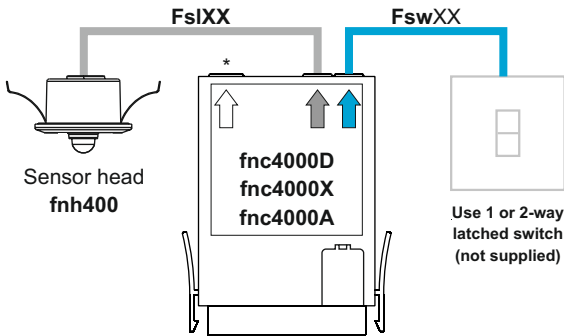

Note: For safe operation it is advisable to extend occupancy coverage to cover the wall switch. In this way, operating the switch to 'SENSOR' position ensures the lights turn ON.

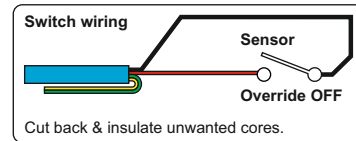

See table below for other switching options

Note: If your room requires 2-way switching, a special 'Y' connector is available to enable two switch drop leads to be connected. (Part No. fsy/2e/2 - OFF control from 2 x 2-way switches)

Operation:

Switch control: Override OFF - turns the lights OFF (takes priority over sensing).

Occupancy detection: Provided the wall switch is in the 'Sensor' position the lights will switch ON whenever there is occupancy detected by the sensor head. When occupancy is no longer detected, lights will switch OFF after a pre-selected *time-out* period (default 20 minutes).

Daylight linking: While lights are ON due to occupancy their light output will adjust to compensate for any changes in ambient light in order to maintain a constant light level under the sensor head - the *target level*.

Other switching options incorporating override ON

Note:

You may not be able to claim enhanced capital allowances under the Carbon Trust scheme if you incorporate local 'override ON' switches in your occupancy sensor scheme.

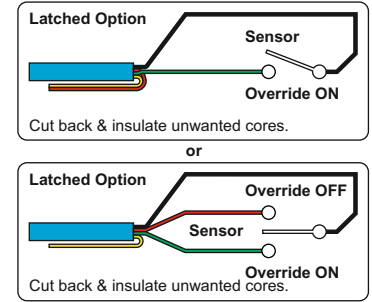

Note: Alternative operational options not necessarily shown above are available using the **frc/set** setup remote control. Full instructions for setting up the sensor are supplied with the sensor head and the **frc/set** remote control - both ordered separately.

Circuit diagram for the fnc4000(D,X or A)

