



Modular lighting connection & control

Why choose flex7?

Lighting connection and control products from flex7 can save you time, hassle and money on your next lighting installation

The flex7 System is a fully modular, prefabricated lighting connection and control system that utilises straightforward plug-in connection. Products simply plug-together on site meaning that it can be installed in a fraction of the time that a traditionally wired system could be completed, with less requirement for skilled labour, as a result of reduced on-site terminations.

We have over 20 years of experience in the lighting connection and control industry. All our products are both designed and manufactured in the UK. Our in-house design team focus on creating high quality, user-friendly products. We understand the need for robust products that can be installed quickly and easily on site, within a strict time frame.

Our wide client base encompasses commercial, education, healthcare, public, high street and transport sectors across the UK and Ireland. The flex7 System is suited to use anywhere, from an individual meeting room to an entire luxury office block; our solution can be as simple, or as complex as you require.





Save Time

Slash installation time on your project.

Save Energy

Installing flex7 lighting controls can reduce a building's energy use by up to 40%.

Simple Maintenance

Once installed, planned and remedial maintenance of the lighting installation couldn't be easier. Individual luminaires and controls can easily be isolated by unplugging from the Distribution Box, and integrated emergency test is an option.

Made In Britain

We're very proud to say that our lighting connection & control system and Prota plug-in ceiling rose are all made in Britain.



Save Money

Reduced installation time on site, and reduced requirement for skilled labour. No expensive commissioning required.

Easy To Install

Products simply plug into one another meaning connection could not be simpler.

Easy To Reconfigure

Extra Distribution Boxes can simply be plugged into existing system to increase no. of outlets, or to add a separately controlled group of luminaires.

BIM Ready

All relevant products are available as Revit files, to be used in Building Information Modelling.



Introduction to the system

- Why choose flex7 page 1
- How it works page 2

Distribution Boxes page 5 - 16

- Lighting Distribution Box wiring diagrams pages 7-10
- Starter Boxes page 11
- Dual Control/Supply Starter Boxes page 11-12
- Expansion Distribution Boxes page 13
- Supply Tap-off Distribution Boxes page 13
- Expansion Leads page 14
- Supply Tap-off Leads page 15
- 2nd Switch Relay Distribution Boxes page 16

Single Socket Outlets page 17-18

Hubs page 19

Auxiliary Adaptor Box & Plugs page 20

Plugs page 21-22

Luminaire Leads page 23-32

- Standard Luminaire Leads page 23
- Maintained Emergency Luminaire Leads page 24
- Dimmable Luminaire Leads page 25
- Dimmable Emergency Luminaire Leads page 26
- Luminaire Leads For Special Applications page 27
- Non-maintained Emergency Luminaire Leads page 28
- Permanent Supply Luminaire Leads page 29
- DALI Luminaire Leads page 30-31
- DALI + Maintained Emergency Luminaire Leads page 31-32

Cable Mount Sockets page 33

Extender & Double-Extender Leads page 34-44

- Mounting Bracket page 35
- Standard Extender Leads page 35
- Maintained Emergency Extender Leads page 35-36
- Dimmable Extender Leads page 36
- Dimmable Maintained Emergency Extender Leads page 37
- Extender Leads For Special Applications page 37-38
- Non-maintained Emergency Extender Leads page 38
- Permanent Supply Extender Leads page 39
- DALI Extender Leads page 40
- DALI + Maintained Emergency Extender Leads page 41
- Standard (On/Off) Double Extender Leads page 42
- Maintained Emergency Double Extender Leads page 42
- Dimmable Double Extender Leads page 42
- Dimmable Maintained Emergency Double Extender Leads page 43
- Double Extender Leads For Special Applications page 43
- DALI Double Extender Leads page 44
- DALI + Maintained Emergency Double Extender Leads page 44

Lighting Controls

page 45-85

Sensor Heads	page 47 - 50
- PIR Sensor Heads	page 47 - 49
- Microwave Sensor Heads	page 50
230V Mains Voltage Microwave Sensor	page 51
Sensor Leads	page 52
Remote Controls	page 52
Individual Control Modules	page 53
Sensor Kits	page 54 - 58
- PIR Sensor Kits for Non-Dimming	page 54
- PIR Sensor Kits for Dimming	page 55
- Microwave Sensor Kits for Non-Dimming	page 56 - 57
- Microwave Sensor Kits for Dimming	page 58
Hotel Room Energy Saving Kit	page 59
Networkable Sensors	page 60 - 67
Corridor Hold Interface	page 67
Timer Management Interface	page 68
Zone Splitter	page 68
3rd Party Control Device Supply Leads	page 69 - 70
Switches	page 71 - 75
- Switch Drop Leads & 'Y' Adaptors	page 72
- Switch Kits	page 73
- Switch Modules	page 74-75
ZoneLite Lighting Control Module	page 76 - 85
- ZoneLite Control Modules	page 77
- ZoneLite PIR Sensor Heads	page 78-80
- ZoneLite Microwave Sensor Heads	page 81
- ZoneLite Remote Control	page 82
- Scene Setting Plates	page 83 - 84
- Conference Room Scene Setting Kit	page 85

Prota Plug-in Ceiling Rose

page 86 - 96

Decorative Covers	page 87
Sockets	page 87
Prota Luminaire Leads	page 88 - 96
- Prota Standard Luminaire Leads	page 88
- Prota Emergency Luminaire Leads	page 89
- Prota Dimmable Luminaire Leads	page 90
- Prota Dimmable Maintained Emergency Luminaire Leads	page 91
- Prota Luminaire Leads For Special Applications	page 92
- Prota Non-Maintained Emergency Luminaire Leads	page 93
- Prota Permanent Supply Luminaire Leads	page 94
- Prota DALI Luminaire Leads	page 95
- Prota DALI + Maintained Emergency Luminaire Leads	page 96

Technical Information

page 97 - 107

Lighting Distribution Boxes

flex7 Lighting Distribution Boxes were designed with the end user in mind. They're manufactured using robust aluminium to easily survive the rigours of installation. A large wiring compartment gives plenty of room for termination of fixed wiring.

All Distribution Boxes come with a spare outlet on the end, which means that an extra box can be plugged in to add further outlets at any time.

Luminaire Leads and Control Modules simply plug into any outlet on the box meaning connection takes seconds.



- Compact and Robust
- 7-Pole as standard - use for on/off or dimming control
- 2-12 way options
- Secure plug-in connection

Large wiring compartment



Fixing options

Conduit Box



Snap In/Out Brackets



Drop Rods



Tray

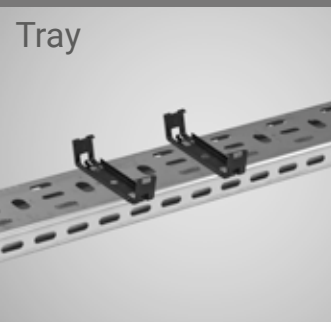

Trunking



Basket



Solid Surface



A fully modular system

If you simply need to connect a single group of luminaires, then a Starter Distribution Box allows you to do just that.

If you want to add extra luminaires at any stage you just need to plug an Expansion Box into your Starter Box, to provide extra outlets.

If you want to control a 2nd group of luminaires separately, share power from your Starter Box with a Supply Tap-off Box, by plugging it into the extra outlet.

You have 2 options for connecting an extra Box:

You can plug them in direct unit-to-unit

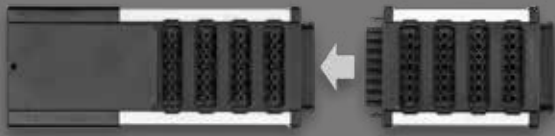

or via a lead.



Alternatives to a standard Starter Distribution Box:

Using a Dual/Control Supply Distribution Box it's also possible to:

Control 2 groups of luminaires independently of each other from a single box.

Independently control 2 groups of luminaires, each supplied by its own protective device at the distribution board (essential/non-essential circuits for example).



Wiring a Lighting Distribution Box

The inherent flexibility of our Lighting Distribution Boxes means they can be used in a multitude of applications. Designed with the installer in mind, wiring / termination can be as simple as Live, Neutral & Earth, whether your control requirements are relatively basic or particularly challenging.

Below you'll find common wiring schematics for each of our three Starter Distribution Box variants when combined with flex7 Plug-in Controls or more traditional hard-wired / 3rd Party controls.

The final schematic in each series simply details the intended use of each terminal; simply choose which to use depending on your application at the time.

Starter Distribution Box – 1 Supply, 1 Control

Using flex7 plug-in control devices c/w integral emergency luminaire test means only a permanent live, neutral and earth are required.

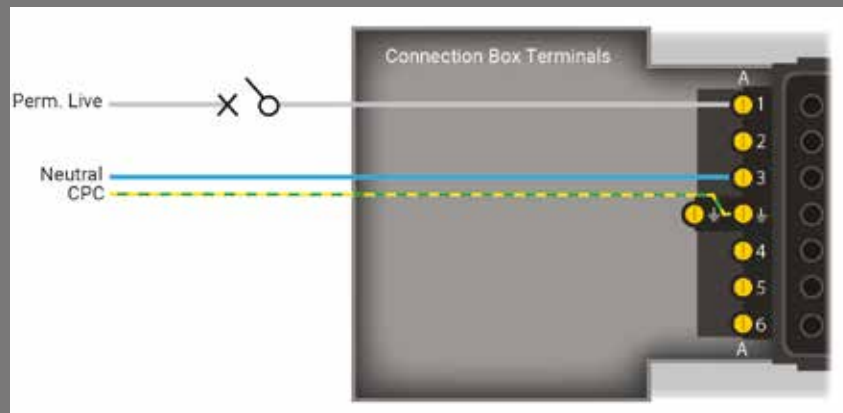

Using flex7 plug-in control devices without integral emergency luminaire test means only a permanent live, emergency live, neutral and earth are required.

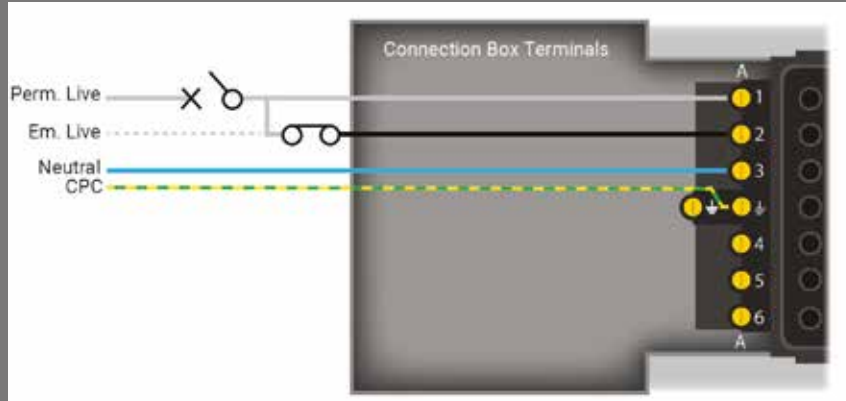

Using more traditional hard-wired control and emergency luminaire test means a permanent live, emergency live, neutral, earth and switch live are required.

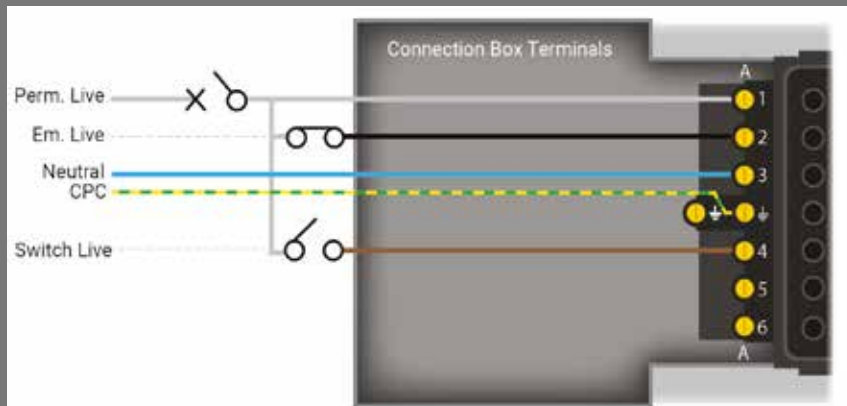

Incorporating alongside a centralised control system means a permanent live, neutral, earth and control pair e.g. DALI are required.

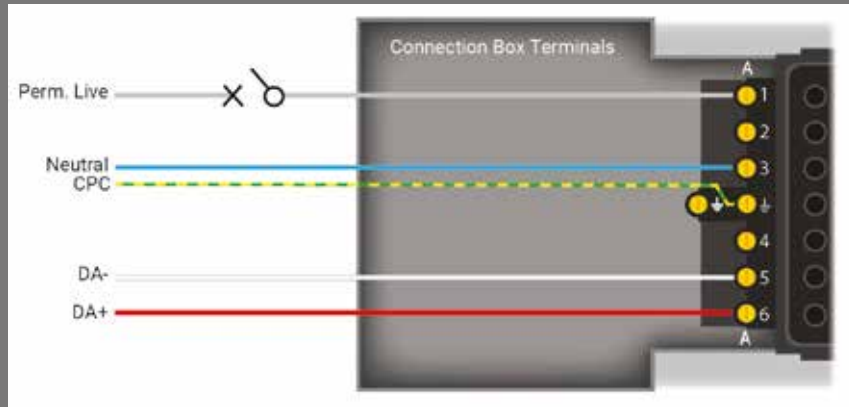

Standard flex7 wiring configuration for all 7 terminals in a starter distribution box.

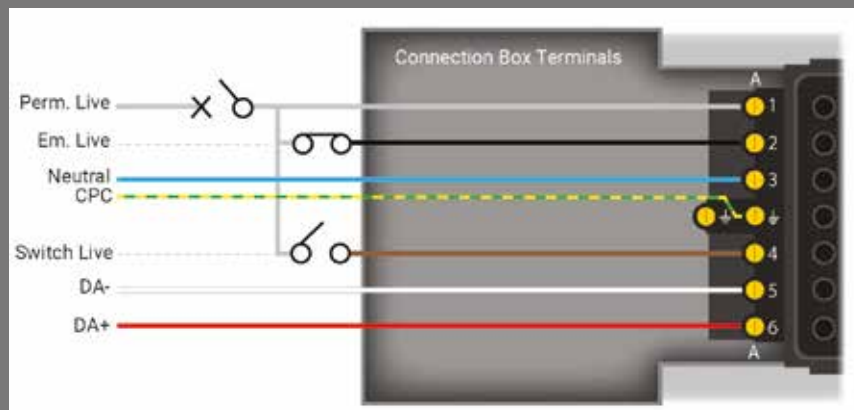

Dual Control/Supply Distribution Box - 1 Supply, 2 Control

Using flex7 plug-in control devices c/w integral emergency luminaire test means only a permanent live, a neutral and earth are required.

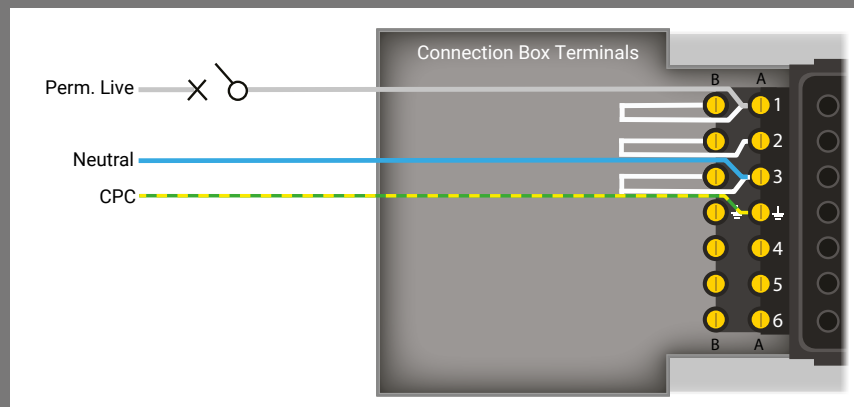

Note: Retain factory fitted link for Dual Control Applications.

Using flex7 plug-in control devices without integral emergency luminaire test means only a permanent live, emergency live, neutral and earth are required.

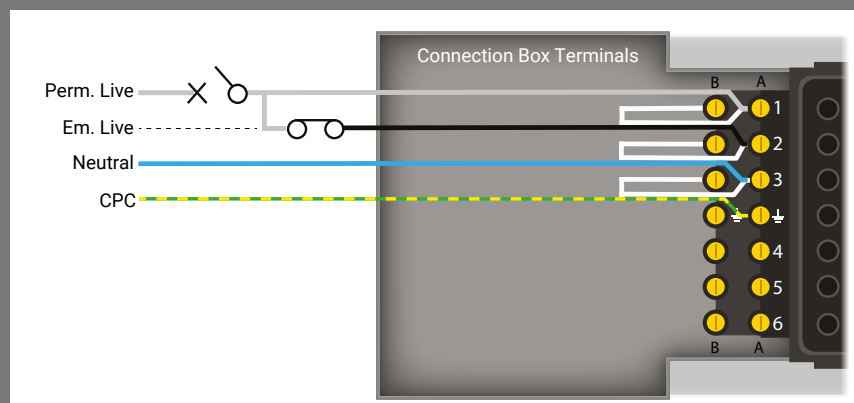

Note: Retain factory fitted link for Dual Control Applications.

Using more traditional hard-wired control and emergency luminaire test means only a permanent live, emergency live, neutral, earth and 2 x switch live are required.

Note: Retain factory fitted link for Dual Control Applications.

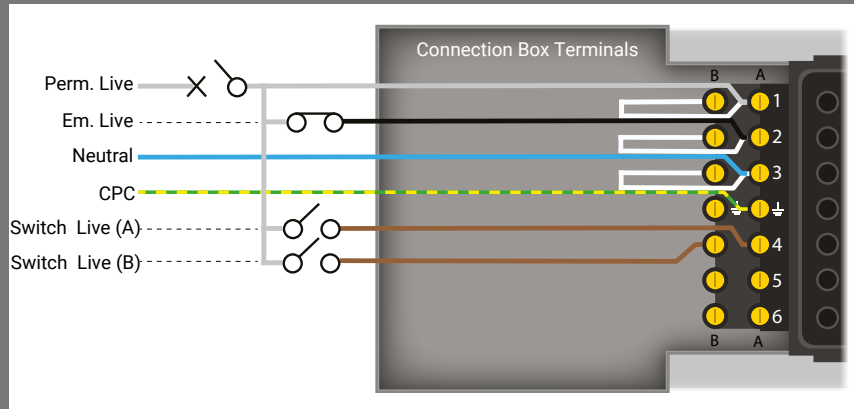

Incorporating alongside a centralised control system means a permanent live, neutral, earth and 2 x control pair (if desired) eg. DALI are required.

Note: Retain factory fitted link for Dual Control Applications.

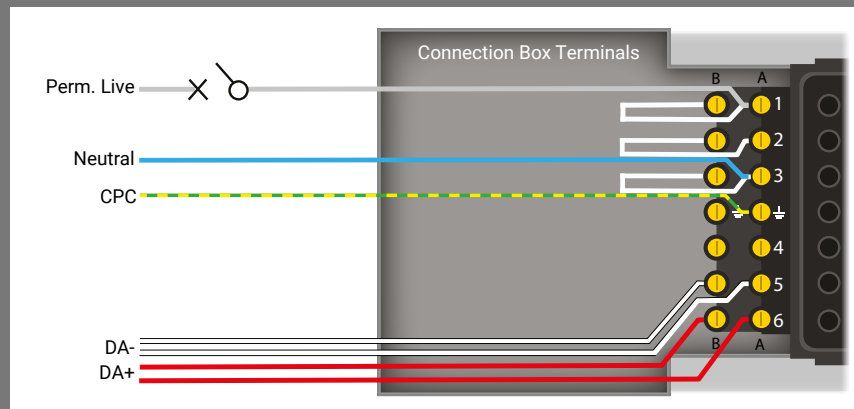

Standard flex7 wiring configurations for all 10 terminals in a Dual Control Application.

Note: Retain factory fitted link for Dual Control Applications.

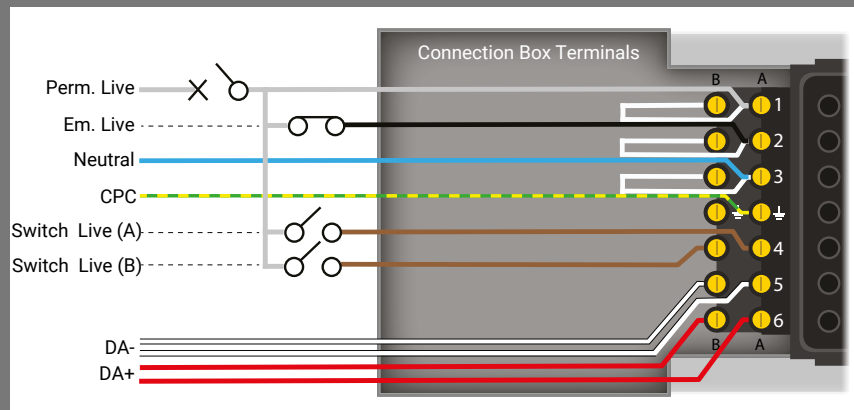

Dual Control/Supply Distribution Box - 2 Supply, 2 Control

Using flex7 plug-in control devices c/w integral emergency luminaire test means 2 x permanent live, 2 x neutral and 2 x earth are required.

Note: Although the two supplies will have different protective devices, they must be the same phase.

Note: Remove factory fitted link for Dual Supply Applications.

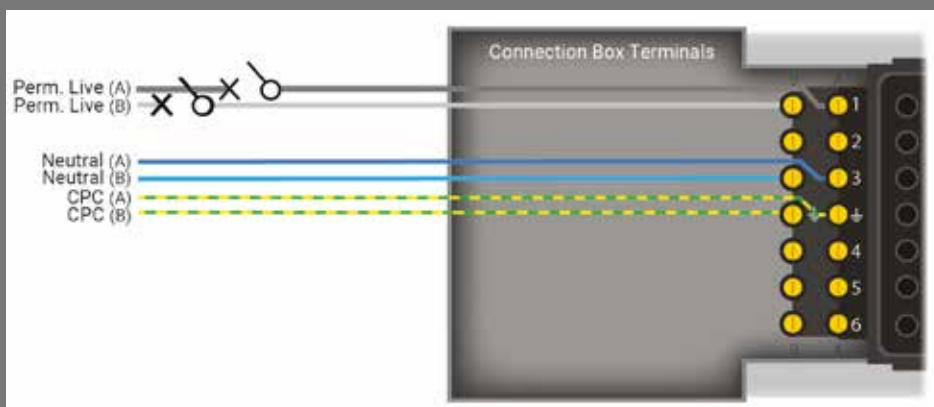

Using flex7 plug-in control devices without integral emergency luminaire test means 2 x permanent live, 2 x emergency live, 2 x neutral and 2 x earth are required.

Note: Although the two supplies will have different protective devices, they must be the same phase.

Note: Remove factory fitted link for Dual Supply Applications.

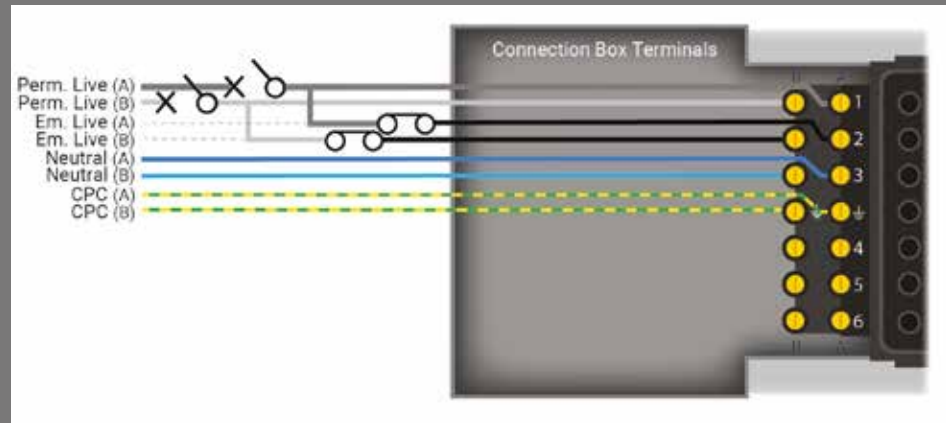

Using more traditional hard-wired control and emergency luminaire test means 2 x permanent live, 2 x emergency live, 2 x neutral, 2 x earth and 2 x switch lives are required.

Note: Although the two supplies will have different protective devices, they must be the same phase.

Note: Remove factory fitted link for Dual Supply Applications.

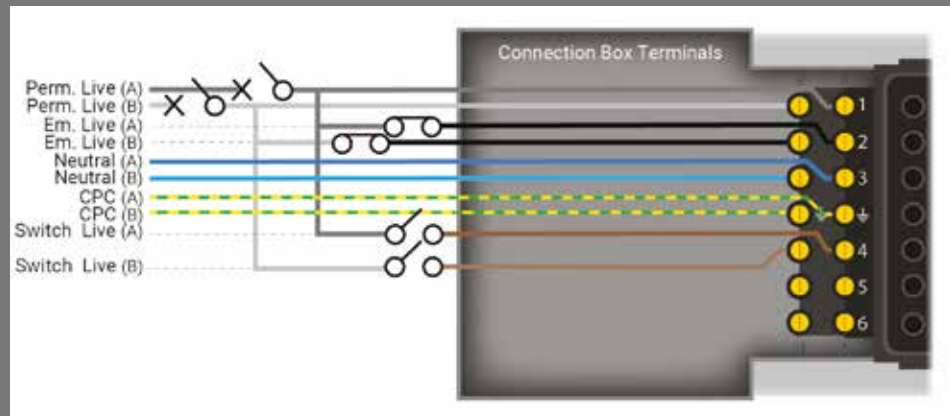

Incorporating alongside a centralised control system means 2 x permanent live, 2 x neutral, 2 x earth and 2 x control pair (if desired) e.g. DALI are required.

Note: Although the two supplies will have different protective devices, they must be the same phase.

Note: Remove factory fitted link for Dual Supply Applications.

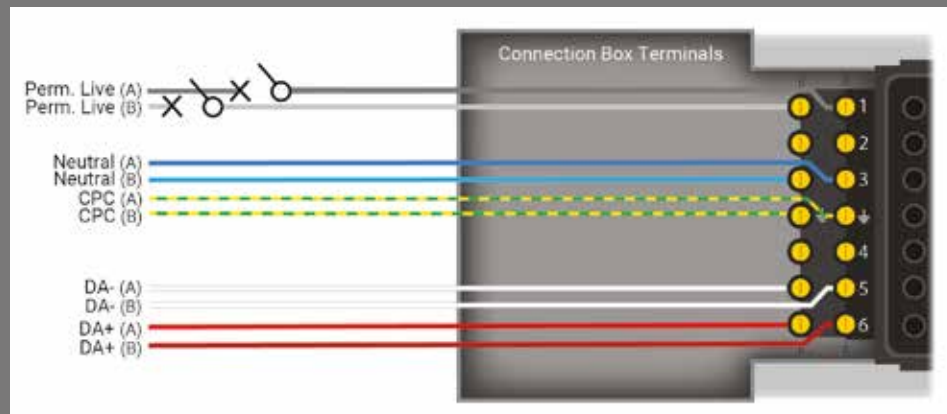

Standard flex7 wiring configuration for all 14 terminals in a Dual Supply Application.

Note: Although the two supplies will have different protective devices, they must be the same phase.

Note: Remove factory fitted link for Dual Supply Applications.

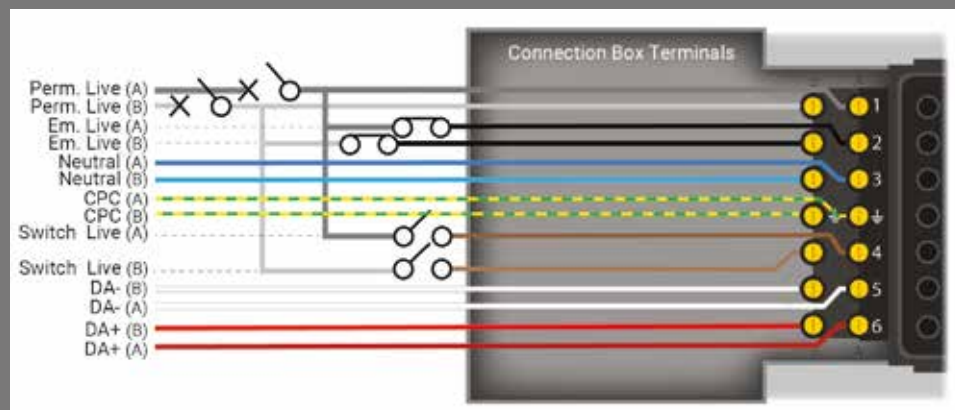



Starter Distribution Boxes

- ▶ Use to connect one group of luminaires.
- ▶ All flex7 Lighting Distribution Boxes support standard (on/off) or dimmable lighting control in emergency or non-emergency versions.

DESCRIPTION	PART NO.	PRICE
2-way Starter Distribution Box	FSU02	£47.76
4-way Starter Distribution Box	FSU04	£65.57
6-way Starter Distribution Box	FSU06	£84.91
8-way Starter Distribution Box	FSU08	£104.21
10-way Starter Distribution Box	FSU10	£124.33
12-way Starter Distribution Box	FSU12	£144.73

Dual Control/Supply Distribution Boxes

Use to control 2 groups of luminaires independently of each other (same circuit, separate control) or to control 2 individual circuits of luminaires (2 protective devices at the distribution board(s) - must be the same phase).

Supplied ready for Dual Control applications and ideal for controlling luminaires adjacent to windows separately to those further away.

Simply remove factory fitted links from wiring compartment terminals for Dual Supply applications. Ideal for Essential / Non-Essential applications in hospitals for example.

Regardless of application, these Distribution Boxes support standard (on/off) or dimmable lighting control in emergency or non-emergency versions.



Dual Control/Supply Distribution Boxes

- ▶ The standard split point is 50:50 as detailed below:

DESCRIPTION	PART NO.	PRICE
2-way Dual Control/Supply Starter Distribution Box, Split 1/1	FSU02DS1/1	£67.65
4-way Dual Control/Supply Starter Distribution Box, Split 2/2	FSU04DS2/2	£85.42
6-way Dual Control/Supply Starter Distribution Box, Split 3/3	FSU06DS3/3	£104.25
8-way Dual Control/Supply Starter Distribution Box, Split 4/4	FSU08DS4/4	£124.20
10-way Dual Control/Supply Starter Distribution Box, Split 5/5	FSU10DS5/5	£142.66
12-way Dual Control/Supply Starter Distribution Box, Split 6/6	FSU12DS6/6	£163.82

Bespoke Dual Control/Supply Distribution Boxes



► The bespoke split points detailed below are built to order:

DESCRIPTION	PART NO.	PRICE
4-way Dual Control/Supply Starter Distribution Box, Split 3/1	FSU04DS3/1	£91.83
6-way Dual Control/Supply Starter Distribution Box, Split 5/1	FSU06DS5/1	£112.07
6-way Dual Control/Supply Starter Distribution Box, Split 4/2	FSU06DS4/2	£112.07
8-way Dual Control/Supply Starter Distribution Box, Split 7/1	FSU08DS7/1	£133.52
8-way Dual Control/Supply Starter Distribution Box, Split 6/2	FSU08DS6/2	£133.52
8-way Dual Control/Supply Starter Distribution Box, Split 5/3	FSU08DS5/3	£133.52
10-way Dual Control/Supply Starter Distribution Box, Split 9/1	FSU10DS9/1	£153.36
10-way Dual Control/Supply Starter Distribution Box, Split 8/2	FSU10DS8/2	£153.36
10-way Dual Control/Supply Starter Distribution Box, Split 7/3	FSU10DS7/3	£153.36
10-way Dual Control/Supply Starter Distribution Box, Split 6/4	FSU10DS6/4	£153.36
12-way Dual Control/Supply Starter Distribution Box, Split 11/1	FSU12DS11/1	£176.11
12-way Dual Control/Supply Starter Distribution Box, Split 10/2	FSU12DS10/2	£176.11
12-way Dual Control/Supply Starter Distribution Box, Split 9/3	FSU12DS9/3	£176.11
12-way Dual Control/Supply Starter Distribution Box, Split 8/4	FSU12DS8/4	£176.11
12-way Dual Control/Supply Starter Distribution Box, Split 7/5	FSU12DS7/5	£176.11

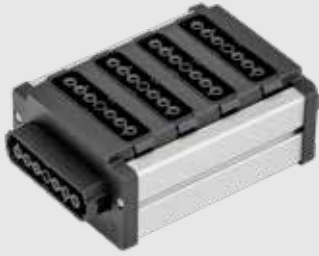

Expansion Distribution Boxes

- ▶ Use to expand the capacity of your preceding Distribution Box eg. plugging a 4-way Expansion Box into an 8-way Starter Box provides a total of 12 outlets.
- ▶ All flex7 Lighting Distribution Boxes support standard (on/off) or dimmable lighting control in emergency or non-emergency versions.
- ▶ Plug-in directly Box to Box, or via a suitable Expansion Lead.
- ▶ Luminaires and Control Module can be plugged into any outlet in either Distribution Box. All connected luminaires will operate together; switching on/off or dimming to the same level in unison.

DESCRIPTION	PART NO.	PRICE
2-way Expansion Distribution Box	FXU02	£43.35
4-way Expansion Distribution Box	FXU04	£63.29
6-way Expansion Distribution Box	FXU06	£83.69
8-way Expansion Distribution Box	FXU08	£103.54
10-way Expansion Distribution Box	FXU10	£123.51
12-way Expansion Distribution Box	FXU12	£143.67

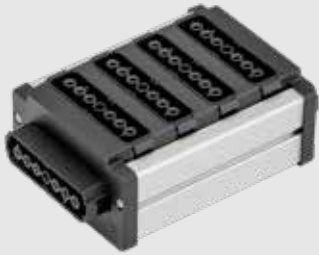

Supply Tap-off Distribution Boxes

- ▶ Use to extend only the supply (not the control) of preceding Distribution Box, to power a separate group of luminaires, and control them independently. A separate Control Module is required.
- ▶ All flex7 Lighting Distribution Boxes support standard (on/off) or dimmable lighting control in emergency or non-emergency versions.
- ▶ Plug-in directly Box to Box, or via a suitable Supply Tap-off Lead.
- ▶ Ideal for distributing one supply over several rooms or areas. Saves valuable installation time, as only the original Starter Box requires fixed wiring termination.

DESCRIPTION	PART NO.	PRICE
2-way Supply Tap-off Distribution Box	FTU02	£40.61
4-way Supply Tap-off Distribution Box	FTU04	£60.68
6-way Supply Tap-off Distribution Box	FTU06	£81.08
8-way Supply Tap-off Distribution Box	FTU08	£100.89
10-way Supply Tap-off Distribution Box	FTU10	£120.99
12-way Supply Tap-off Distribution Box	FTU12	£141.20

Expansion Leads

Use if you wish your Expansion Distribution Box to be remote from your preceding Distribution Box eg. you may wish to keep all luminaire leads short along a corridor by using Expansion Distribution Boxes linked together via Expansion Leads.

Can also be used if a Single Socket Outlet or 6-circuit Hub Box is preferred as the initial source. This provides complete flexibility to choose the correct plug-in Box/es at second fix / fit-out.

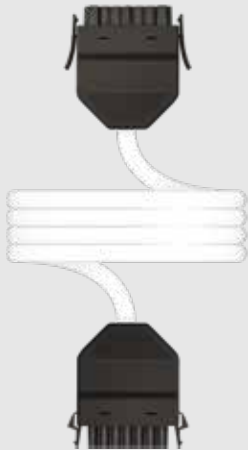

Standard Expansion Leads

- ▶ Use where luminaire control is standard (on/off). Supplied with black plug and socket.

DESCRIPTION	LSHF CABLE	PRICE
1.50mm cable, 2 metre	FX5150LSHF2/B	£32.82
1.50mm cable, 3 metre	FX5150LSHF3/B	£37.54
1.50mm cable, 5 metre	FX5150LSHF5/B	£46.12
1.50mm cable, 7 metre	FX5150LSHF7/B	£55.29

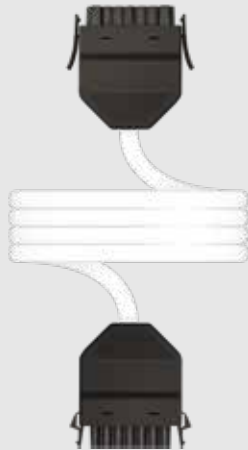

Dimming Expansion Leads

- ▶ Use where luminaire control is dimmable. Supplied with black plug and socket.

DESCRIPTION	LSHF CABLE	PRICE
1.50mm cable, 2 metre	FX7150LSHF2/B	£42.11
1.50mm cable, 3 metre	FX7150LSHF3/B	£48.90
1.50mm cable, 5 metre	FX7150LSHF5/B	£62.54
1.50mm cable, 7 metre	FX7150LSHF7/B	£77.28

Supply Tap-off Leads

Use if you wish your Supply Tap-off Box to be remote from the preceding Distribution Box. Can also be used if a Single Socket Outlet or Hub Box is preferred as the initial source. This provides complete flexibility to choose the correct plug-in Box/es at second fix/fit-out.

Ideal for distributing one supply over several rooms or areas. Saves valuable time as only the original Starter Box requires fixed wiring termination.



3-core

- ▶ Use where each interconnected Tap-off Box has its own plug-in emergency test facility. Supplied with a black plug and socket.

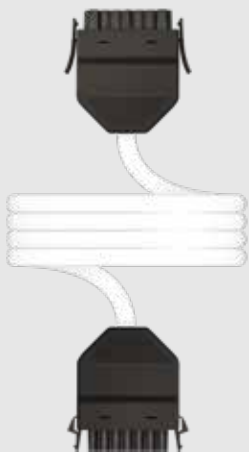

DESCRIPTION	LSHF CABLE	PRICE
1.50mm cable, 2 metre	FT3150LSHF2/B	£24.38
1.50mm cable, 3 metre	FT3150LSHF3/B	£27.23
1.50mm cable, 5 metre	FT3150LSHF5/B	£32.45
1.50mm cable, 7 metre	FT3150LSHF7/B	£38.16

4-Core

- ▶ Use where the emergency test is common to all interconnected Tap-off Boxes. Supplied with a black plug and socket.

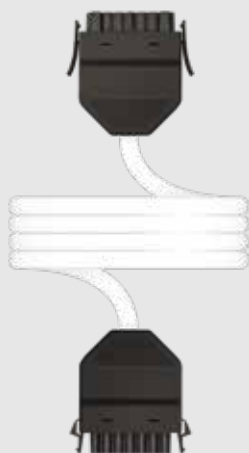

DESCRIPTION	LSHF CABLE	PRICE
1.50mm cable, 2 metre	FT4150LSHF2/B	£28.46
1.50mm cable, 3 metre	FT4150LSHF3/B	£32.33
1.50mm cable, 5 metre	FT4150LSHF5/B	£40.08
1.50mm cable, 7 metre	FT4150LSHF7/B	£47.72

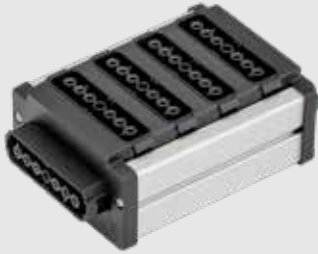

2nd Switch Relay Distribution Boxes

- ▶ Use to control 2 groups of luminaires in conjunction with a Control Module incorporating a 2nd Switch Relay.
- ▶ All flex7 Lighting Distribution Boxes support standard (on/off) or dimmable lighting control in emergency or non-emergency versions.
- ▶ Ideal for controlling non-dimmable luminaires adjacent to windows, separately to those further away.
- ▶ The F2U Distribution Box must be plugged into a preceding box (preceding box controlled by relay 1, F2U Distribution Box controlled by relay 2).
- ▶ Note: F2U box is not required for Control Modules incorporating an emergency test relay.

DESCRIPTION	PART NO.	PRICE
4-way 2nd Switch Relay Distribution Box	F2U04	£78.21
6-way 2nd Switch Relay Distribution Box	F2U06	£100.89
8-way 2nd Switch Relay Distribution Box	F2U08	£120.67
10-way 2nd Switch Relay Distribution Box	F2U10	£140.90
12-way 2nd Switch Relay Distribution Box	F2U12	£160.73

Single Socket Outlets

Single Sockets are ideal where only one outlet is required. Available in 3, 4, 5, 6 and 7-pole variations.

You can use a Single Socket Outlet as the initial power source to simplify and standardise the first fix. This provides complete flexibility to choose the correct plug-in Box/es at the second fix.



Large in-line terminals



Available in 3-7 poles.



16A Rated

16A

Please note: Boxes of 300 are packed loose (not in boxes of 10), and can only be ordered in multiples of 300.

3-Pole Socket

► Use with standard (on/off) luminaires.



DESCRIPTION	PART NO. (BOX OF 10)	PRICE	PART NO. (BOX OF 300)	PRICE
White 3-pole socket	FTS03/W	£5.18 EA.	FTS03/W/300	£5.07 EA.
Red 3-pole socket	FTS03/R	£5.18 EA.	FTS03/R/300	£5.07 EA.
Black 3-pole socket	FTS03/B	£5.18 EA.	FTS03/B/300	£5.07 EA.
Grey 3-pole socket	FTS03/G	£5.18 EA.	FTS03/G/300	£5.07 EA.

4-Pole Socket

► Use with standard (on/off) + emergency luminaires.



DESCRIPTION	PART NO. (BOX OF 10)	PRICE	PART NO. (BOX OF 300)	PRICE
Red 4-pole socket	FTS04/R	£6.14 EA.	FTS04/R/300	£6.02 EA.
White 4-pole socket	FTS04/W	£6.14 EA.	FTS04/W/300	£6.02 EA.
Black 4-pole socket	FTS04/B	£6.14 EA.	FTS04/B/300	£6.02 EA.
Grey 4-pole socket	FTS04/G	£6.14 EA..	FTS04/G/300	£6.02 EA.



5-Pole Socket

► Use with dimmable luminaires.

DESCRIPTION	PART NO. (BOX OF 10)	PRICE	PART NO. (BOX OF 300)	PRICE
Black 5-pole socket	FTS05/B	£6.93 EA.	FTS05/B/300	£6.82 EA.
White 5-pole socket	FTS05/W	£6.93 EA.	FTS05/W/300	£6.82 EA.
Red 5-pole socket	FTS05/R	£6.93 EA.	FTS05/R/300	£6.82 EA.
Grey 5-pole socket	FTS05/G	£6.93 EA.	FTS05/G/300	£6.82 EA.



6-Pole Socket

► Use with dimmable + emergency luminaires.

DESCRIPTION	PART NO. (BOX OF 10)	PRICE	PART NO. (BOX OF 300)	PRICE
Red 6-pole socket	FTS06/R	£7.96 EA.	FTS06/R/300	£7.85 EA.
White 6-pole socket	FTS06/W	£7.96 EA.	FTS06/W/300	£7.85 EA.
Black 6-pole socket	FTS06/B	£7.96 EA.	FTS06/B/300	£7.85 EA.
Grey 6-pole socket	FTS06/G	£7.96 EA.	FTS06/G/300	£7.85 EA.

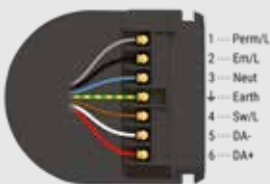

7-Pole Socket

► Use with special applications.

DESCRIPTION	PART NO. (BOX OF 10)	PRICE	PART NO. (BOX OF 300)	PRICE
Black 7-pole socket	FTS07/B	£9.05 EA.	FTS07/B/300	£8.93 EA.
White 7-pole socket	FTS07/W	£9.05 EA.	FTS07/W/300	£8.93 EA.
Red 7-pole socket	FTS07/R	£9.05 EA.	FTS07/R/300	£8.93 EA.
Grey 7-pole socket	FTS07/G	£9.05 EA.	FTS07/G/300	£8.93 EA.



Trunking Mount Plate

► Use to fix your socket to trunking, cable tray or basket instead of a BESA box.

DESCRIPTION	PART NO.	PRICE
20mm Ø Cutout, Black (box of 10)	TM/20/B	£1.72 EA.
20mm Ø Cutout, White (box of 10)	TM/20/W	£1.72 EA.
20mm Ø Cutout, Red (box of 10)	TM/20/R	£1.72 EA.
20mm Ø Cutout, Grey (box of 10)	TM/20/G	£1.72 EA.
25mm Ø Cutout, Black (box of 10)	TM/25/B	£1.72 EA.
25mm Ø Cutout, White (box of 10)	TM/25/W	£1.72 EA.
25mm Ø Cutout, Red (box of 10)	TM/25/R	£1.72 EA.
25mm Ø Cutout, Grey (box of 10)	TM/25/G	£1.72 EA.

Hubs

Protected by 6 separate devices at the distribution board. Use a hub to provide up to 6 individual supplies, housed in a single enclosure. From there plug-in Expansion Boxes, Tap-off Boxes, Single, or Double Extender Leads as required.

A Hub is essentially 6 separate 7-pole Single Socket Outlets housed in one enclosure into which can be terminated a suitable multi-core cable carrying power and, where necessary, control wiring. It can accommodate supplies on different phases and any additional control wiring as required eg. DALI.



Hub

DESCRIPTION	PART NO.	PRICE
6-circuit Hub	FHU06	£219.44

2-Pole Auxiliary Adaptor Box

Use as a convenient point of termination for the fixed wiring of a 3rd party's 2-wire control or monitoring system (eg. a centralised emergency luminaire monitoring system).

Attaches directly onto any flex7 Distribution Box (6-way or larger), providing a single point for the connection/disconnection of a luminaire's power, control, plus 3rd party's monitoring etc.

Connect the 3rd party's device using an Auxiliary Adaptor Box Plug, which simply plugs into one of the Auxiliary Adaptor Box's outlets.



2-Pole Auxiliary Adaptor Box

DESCRIPTION	PART NO.	PRICE
4-way Auxiliary Adaptor Box	FAA2/04	£62.63



2-Pole Auxiliary Adaptor Box Plug

- ▶ Use to connect a luminaire to an Auxiliary Adaptor Box.

DESCRIPTION	PART NO.	PRICE
White/Blue 2-Pole Plug (unwired)	FA2/BL	£10.56

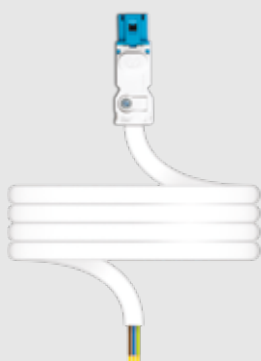

2-Pole Auxiliary Adaptor Box Prewired Plug

- ▶ Use to connect a luminaire to an Auxiliary Adaptor Box. Prewired for your convenience.
- ▶ The lead is stripped, and ferruled ready for connection.

DESCRIPTION	PART NO.	PRICE
1.50mm flexible cable, 2 metre	FA2150LSHF2/BL	£15.55
1.50mm flexible cable, 3 metre	FA2150LSHF3/BL	£18.36
1.50mm flexible cable, 5 metre	FA2150LSHF5/BL	£24.24
1.50mm flexible cable, 7 metre	FA2150LSHF7/BL	£29.95

Plugs

Available in white, red, black, or grey, flex7 plugs are robust and simple to use. In-line terminals, and a pair of screws which both secure the cover and clamp the flexible cable, make it quick and easy to wire on site.



Large wiring compartment



Clearly labelled in-line terminals



Strong latches ensure secure connection



4 standard colours for identification of load



Please note: Boxes of 300 are packed loose (not in boxes of 10), and can only be ordered in multiples of 300.

3-Pin Plug

► Use with standard (on/off) luminaires.



DESCRIPTION	PART NO. (BOX OF 10)	PRICE	PART NO. (BOX OF 300)	PRICE
White 3-pin plug (unwired)	FP3/W	£5.02 EA.	FP3/W/300	£4.90 EA.
Red 3-pin plug (unwired)	FP3/R	£5.02 EA.	FP3/R/300	£4.90 EA.
Black 3-pin plug (unwired)	FP3/B	£5.02 EA.	FP3/B/300	£4.90 EA.
Grey 3-pin plug (unwired)	FP3/G	£5.02 EA.	FP3/G/300	£4.90 EA.

4-Pin Plug

► Use with standard (on/off) + emergency luminaires.



DESCRIPTION	PART NO. (BOX OF 10)	PRICE	PART NO. (BOX OF 300)	PRICE
Red 4-pin plug (unwired)	FP4/R	£5.86 EA.	FP4/R/300	£5.74 EA.
White 4-pin plug (unwired)	FP4/W	£5.86 EA.	FP4/W/300	£5.74 EA.
Black 4-pin plug (unwired)	FP4/B	£5.86 EA.	FP4/B/300	£5.74 EA.
Grey 4-pin plug (unwired)	FP4/G	£5.86 EA.	FP4/G/300	£5.74 EA.



5-Pin Plug

- ▶ Use with dimmable luminaires. Note live terminal (4) is switched live

DESCRIPTION	PART NO. (BOX OF 10)	PRICE	PART NO. (BOX OF 300)	PRICE
Black 5-pin plug (unwired)	FP5/B	£6.08 EA.	FP5/B/300	£5.96 EA.
White 5-pin plug (unwired)	FP5/W	£6.08 EA.	FP5/W/300	£5.96 EA.
Red 5-pin plug (unwired)	FP5/R	£6.08 EA.	FP5/R/300	£5.96 EA.
Grey 5-pin plug (unwired)	FP5/G	£6.08 EA.	FP5/G/300	£5.96EA.



6-Pin Plug

- ▶ Use with dimmable + emergency luminaires. Note live terminal (4) is switched live

DESCRIPTION	PART NO. (BOX OF 10)	PRICE	PART NO. (BOX OF 300)	PRICE
Red 6-pin plug (unwired)	FP6/R	£6.97 EA.	FP6/R/300	£6.86 EA.
White 6-pin plug (unwired)	FP6/W	£6.97 EA.	FP6/W/300	£6.86 EA.
Black 6-pin plug (unwired)	FP6/B	£6.97 EA.	FP6/B/300	£6.86 EA.
Grey 6-pin plug (unwired)	FP6/G	£6.97 EA.	FP6/G/300	£6.86 EA.



7-Pin Plug

- ▶ Use for special applications including where DALI luminaire requires permanent live rather than switched live.

DESCRIPTION	PART NO. (BOX OF 10)	PRICE	PART NO. (BOX OF 300)	PRICE
Black 7-pin plug (unwired)	FP7/B	£7.74 EA.	FP7/B/300	£7.62 EA.
White 7-pin plug (unwired)	FP7/W	£7.74 EA.	FP7/W/300	£7.62 EA.
Red 7-pin plug (unwired)	FP7/R	£7.74 EA.	FP7/R/300	£7.62 EA.
Grey 7-pin plug (unwired)	FP7/G	£7.74 EA.	FP7/G/300	£7.62 EA.

Luminaire Leads

We offer an extensive range of luminaire leads which minimise installation time. All variants are available in Low Smoke Halogen Free (LSHF) cable, in accordance with BS EN 50525-3-11 and CPR rated to category Cca, so you can be assured that they'll meet required safety standards for public and commercial buildings.

Non-associative colours, and other cable lengths may be available to special order. Please phone us on 020 8580 1066 for part numbers or advice.



Standard Luminaire Leads, All White

- ▶ 3-core luminaire lead for use with standard (on/off) luminaires.
- ▶ All luminaires leads in range are 100% tested, and come with ferruled conductors at free end.
- ▶ Compatible with all Distribution Boxes.
- ▶ Socket compatibility: FTS03/W ✓ FTS04/W ✓ FTS05/W ✓ FTS06/W ✓ FTS07/W ✓



DESCRIPTION	PART NO.	PRICE
0.75mm cable, 2 metre	FL375LSHF2/W	£10.76
0.75mm cable, 3 metre	FL375LSHF3/W	£12.63
0.75mm cable, 5 metre	FL375LSHF5/W	£16.51
0.75mm cable, 7 metre	FL375LSHF7/W	£19.81
1.00mm cable, 2 metre	FL3100LSHF2/W	£11.49
1.00mm cable, 3 metre	FL3100LSHF3/W	£13.72
1.00mm cable, 5 metre	FL3100LSHF5/W	£17.97
1.00mm cable, 7 metre	FL3100LSHF7/W	£22.25
1.50mm cable, 2 metre	FL3150LSHF2/W	£13.01
1.50mm cable, 3 metre	FL3150LSHF3/W	£15.66
1.50mm cable, 5 metre	FL3150LSHF5/W	£21.41
1.50mm cable, 7 metre	FL3150LSHF7/W	£26.91

Standard Luminaire Leads, All Black

- ▶ 3-core luminaire lead for use with standard (on/off) luminaires.
- ▶ All luminaires leads in range are 100% tested, and come with ferruled conductors at free end.
- ▶ Compatible with all Distribution Boxes.
- ▶ Socket compatibility: FTS03/W ✓ FTS04/W ✓ FTS05/W ✓ FTS06/W ✓ FTS07/W ✓



DESCRIPTION	PART NO.	PRICE
1.00mm cable, 2 metre	FL3100LSHF2/BB	£12.59
1.00mm cable, 3 metre	FL3100LSHF3/BB	£14.78
1.00mm cable, 5 metre	FL3100LSHF5/BB	£19.24
1.00mm cable, 7 metre	FL3100LSHF7/BB	£23.67

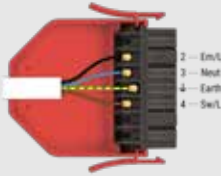

Maintained Emergency Luminaire Leads, Red With White Cable

- ▶ 4-core luminaire lead for use with standard (on/off) + maintained emergency luminaires.
- ▶ All luminaire leads in range are 100% tested, and come with ferruled conductors at free end.
- ▶ Compatible with all Distribution Boxes.
- ▶ Socket compatibility:

FTS03/R	✗	FTS04/R	✓	FTS05/R	✗	FTS06/R	✓	FTS07/R	✓
---------	---	---------	---	---------	---	---------	---	---------	---

DESCRIPTION	PART NO.	PRICE
0.75mm cable, 2 metre	FL475LSHF2/R	£12.84
0.75mm cable, 3 metre	FL475LSHF3/R	£15.21
0.75mm cable, 5 metre	FL475LSHF5/R	£19.99
0.75mm cable, 7 metre	FL475LSHF7/R	£24.53
1.00mm cable, 2 metre	FL4100LSHF2/R	£14.20
1.00mm cable, 3 metre	FL4100LSHF3/R	£16.88
1.00mm cable, 5 metre	FL4100LSHF5/R	£22.74
1.00mm cable, 7 metre	FL4100LSHF7/R	£28.88
1.50mm cable, 2 metre	FL4150LSHF2/R	£16.34
1.50mm cable, 3 metre	FL4150LSHF3/R	£20.30
1.50mm cable, 5 metre	FL4150LSHF5/R	£28.00
1.50mm cable, 7 metre	FL4150LSHF7/R	£35.42



Maintained Emergency Luminaire Leads, All Black

- ▶ 4-core luminaire lead for use with standard (on/off) + maintained emergency luminaires.
- ▶ All luminaire leads in range are 100% tested, and come with ferruled conductors at free end.
- ▶ Compatible with all Distribution Boxes.
- ▶ Socket compatibility:

FTS03/R	✗	FTS04/R	✓	FTS05/R	✗	FTS06/R	✓	FTS07/R	✓
---------	---	---------	---	---------	---	---------	---	---------	---

DESCRIPTION	PART NO.	PRICE
1.00mm cable, 2 metre	FL4100LSHF2/BB	£15.33
1.00mm cable, 3 metre	FL4100LSHF3/BB	£18.36
1.00mm cable, 5 metre	FL4100LSHF5/BB	£24.43
1.00mm cable, 7 metre	FL4100LSHF7/BB	£30.46

Dimmable Luminaire Leads, Black With White Cable

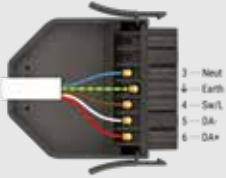
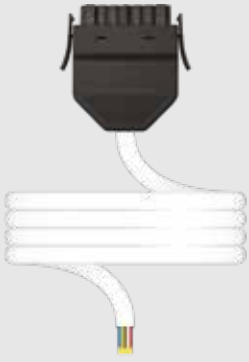

- ▶ 5-core luminaire lead for use with dimmable luminaires. Note live terminal (4) is switched live.
- ▶ All luminaire leads in range are 100% tested, and come with ferruled conductors at free end.
- ▶ Compatible with all Distribution Boxes.
- ▶ Socket compatibility:

FTS03/B	✗	FTS04/B	✗	FTS05/B	✓	FTS06/B	✓	FTS07/B	✓
---------	---	---------	---	---------	---	---------	---	---------	---

DESCRIPTION	PART NO.	PRICE
0.75mm cable, 2 metre	FL575LSHF2/B	£15.56
0.75mm cable, 3 metre	FL575LSHF3/B	£18.67
0.75mm cable, 5 metre	FL575LSHF5/B	£24.97
0.75mm cable, 7 metre	FL575LSHF7/B	£30.93
1.00mm cable, 2 metre	FL5100LSHF2/B	£16.53
1.00mm cable, 3 metre	FL5100LSHF3/B	£20.09
1.00mm cable, 5 metre	FL5100LSHF5/B	£27.14
1.00mm cable, 7 metre	FL5100LSHF7/B	£33.88
1.50mm cable, 2 metre	FL5150LSHF2/B	£19.08
1.50mm cable, 3 metre	FL5150LSHF3/B	£23.77
1.50mm cable, 5 metre	FL5150LSHF5/B	£33.00
1.50mm cable, 7 metre	FL5150LSHF7/B	£41.84

Dimmable Luminaire Leads, All Black



- ▶ 5-core luminaire lead for use with dimmable luminaires. Note live terminal (4) is switched live
- ▶ All luminaire leads in range are 100% tested, and come with ferruled conductors at free end.
- ▶ Compatible with all Distribution Boxes.
- ▶ Socket compatibility:

FTS03/B	✗	FTS04/B	✗	FTS05/B	✓	FTS06/B	✓	FTS07/B	✓
---------	---	---------	---	---------	---	---------	---	---------	---

DESCRIPTION	PART NO.	PRICE
1.00mm cable, 2 metre	FL5100LSHF2/BB	£19.18
1.00mm cable, 3 metre	FL5100LSHF3/BB	£23.26
1.00mm cable, 5 metre	FL5100LSHF5/BB	£31.38
1.00mm cable, 7 metre	FL5100LSHF7/BB	£39.53

Dimmable Maintained Emergency Luminaire Leads, Red With White Cable

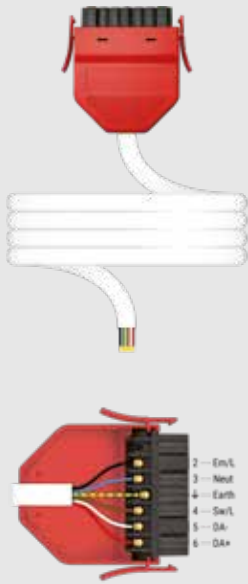

- ▶ 6-core luminaire lead for use with dimmable + maintained emergency luminaires.
- ▶ All luminaire leads in range are 100% tested, and come with ferruled conductors at free end.
- ▶ Compatible with all Distribution Boxes.
- ▶ Socket compatibility:

FTS03/R	✗	FTS04/R	✗	FTS05/R	✗	FTS06/R	✓	FTS07/R	✓
---------	---	---------	---	---------	---	---------	---	---------	---

DESCRIPTION	PART NO.	PRICE
0.75mm cable, 2 metre	FL675LSHF2/R	£19.87
0.75mm cable, 3 metre	FL675LSHF3/R	£23.75
0.75mm cable, 5 metre	FL675LSHF5/R	£32.84
0.75mm cable, 7 metre	FL675LSHF7/R	£41.10
1.00mm cable, 2 metre	FL6100LSHF2/R	£20.28
1.00mm cable, 3 metre	FL6100LSHF3/R	£24.87
1.00mm cable, 5 metre	FL6100LSHF5/R	£34.69
1.00mm cable, 7 metre	FL6100LSHF7/R	£43.55
1.50mm cable, 2 metre	FL6150LSHF2/R	£23.10
1.50mm cable, 3 metre	FL6150LSHF3/R	£28.78
1.50mm cable, 5 metre	FL6150LSHF5/R	£40.59
1.50mm cable, 7 metre	FL6150LSHF7/R	£52.28

Dimmable Maintained Emergency Luminaire Leads, All Black

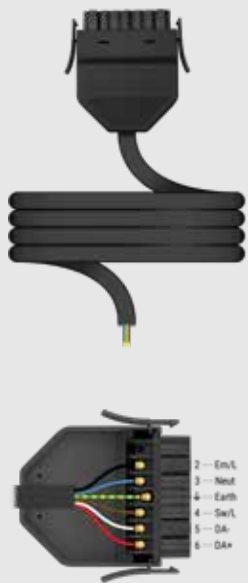

- ▶ 6-core luminaire lead for use with dimmable + maintained emergency luminaires.
- ▶ All luminaire leads in range are 100% tested, and come with ferruled conductors at free end.
- ▶ Compatible with all Distribution Boxes.
- ▶ Socket compatibility:

FTS03/R	✗	FTS04/R	✗	FTS05/R	✗	FTS06/R	✓	FTS07/R	✓
---------	---	---------	---	---------	---	---------	---	---------	---

DESCRIPTION	PART NO.	PRICE
1.00mm cable, 2 metre	FL6100LSHF2/BB	£22.60
1.00mm cable, 3 metre	FL6100LSHF3/BB	£27.76
1.00mm cable, 5 metre	FL6100LSHF5/BB	£38.07
1.00mm cable, 7 metre	FL6100LSHF7/BB	£48.26

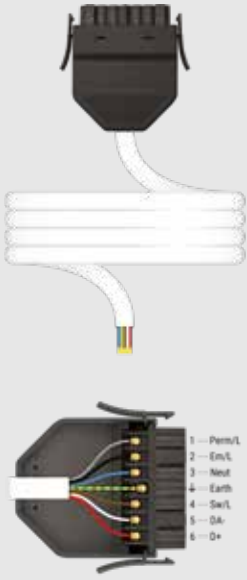

Luminaire Leads For Special Applications, Black With White Cable

- ▶ 7-core luminaire lead for use with bespoke luminaires eg. luminaires that have multiple switch lives.
- ▶ All luminaire leads in range are 100% tested, and come with ferruled conductors at free end.
- ▶ Compatible with all Distribution Boxes.
- ▶ Socket compatibility: FTS03/B ✗ FTS04/B ✗ FTS05/B ✗ FTS06/B ✗ FTS07/B ✓

DESCRIPTION	PART NO.	PRICE
0.75mm cable, 2 metre	FL775LSHF2/B	£20.85
0.75mm cable, 3 metre	FL775LSHF3/B	£25.28
0.75mm cable, 5 metre	FL775LSHF5/B	£34.10
0.75mm cable, 7 metre	FL775LSHF7/B	£43.32
1.00mm cable, 2 metre	FL7100LSHF2/B	£22.17
1.00mm cable, 3 metre	FL7100LSHF3/B	£27.26
1.00mm cable, 5 metre	FL7100LSHF5/B	£38.05
1.00mm cable, 7 metre	FL7100LSHF7/B	£47.80
1.50mm cable, 2 metre	FL7150LSHF2/B	£27.01
1.50mm cable, 3 metre	FL7150LSHF3/B	£33.86
1.50mm cable, 5 metre	FL7150LSHF5/B	£47.31
1.50mm cable, 7 metre	FL7150LSHF7/B	£61.26

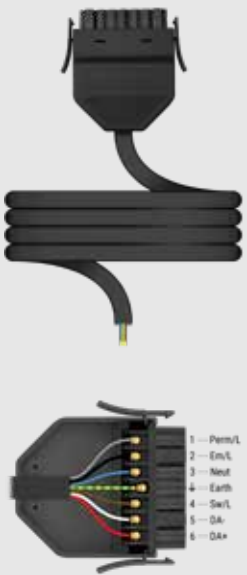

Luminaire Leads For Special Applications, All Black

- ▶ 7-core luminaire lead for use with bespoke luminaires eg. luminaires that have multiple switch lives.
- ▶ All luminaire leads in range are 100% tested, and come with ferruled conductors at free end.
- ▶ Compatible with all Distribution Boxes.
- ▶ Socket compatibility: FTS03/B ✗ FTS04/B ✗ FTS05/B ✗ FTS06/B ✗ FTS07/B ✓

DESCRIPTION	PART NO.	PRICE
1.00mm cable, 2 metre	FL7100LSHF2/BB	£25.10
1.00mm cable, 3 metre	FL7100LSHF3/BB	£30.92
1.00mm cable, 5 metre	FL7100LSHF5/BB	£42.57
1.00mm cable, 7 metre	FL7100LSHF7/BB	£54.11

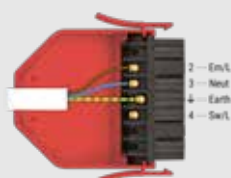

Non-maintained Emergency Luminaire Leads, Red With White Cable

- ▶ 3-core luminaire lead for use with non-maintained, emergency luminaires.
- ▶ All luminaires leads in range are 100% tested and come with ferruled conductors at free end.
- ▶ Compatible with all Distribution Boxes.
- ▶ Socket compatibility:

FTS03/R	✘	FTS04/R	✔	FTS05/R	✘	FTS06/R	✔	FTS07/R	✔
---------	---	---------	---	---------	---	---------	---	---------	---

DESCRIPTION	PART NO.	PRICE
0.75mm cable, 2 metre	FL375LSHF2/RE	£12.07
0.75mm cable, 3 metre	FL375LSHF3/RE	£14.03
0.75mm cable, 5 metre	FL375LSHF5/RE	£18.11
0.75mm cable, 7 metre	FL375LSHF7/RE	£21.56
1.00mm cable, 2 metre	FL3100LSHF2/RE	£12.81
1.00mm cable, 3 metre	FL3100LSHF3/RE	£15.18
1.00mm cable, 5 metre	FL3100LSHF5/RE	£19.60
1.00mm cable, 7 metre	FL3100LSHF7/RE	£24.13
1.50mm cable, 2 metre	FL3150LSHF2/RE	£14.41
1.50mm cable, 3 metre	FL3150LSHF3/RE	£17.50
1.50mm cable, 5 metre	FL3150LSHF5/RE	£23.23
1.50mm cable, 7 metre	FL3150LSHF7/RE	£29.04



Non-maintained Emergency Luminaire Leads, All Black

- ▶ 3-core luminaire lead for use with non-maintained, emergency luminaires.
- ▶ All luminaires leads in range are 100% tested and come with ferruled conductors at free end.
- ▶ Compatible with all Distribution Boxes.
- ▶ Socket compatibility:

FTS03/R	✘	FTS04/R	✔	FTS05/R	✘	FTS06/R	✔	FTS07/R	✔
---------	---	---------	---	---------	---	---------	---	---------	---

DESCRIPTION	PART NO.	PRICE
1.00mm cable, 2 metre	FL3100LSHF2/BBE	£13.76
1.00mm cable, 3 metre	FL3100LSHF3/BBE	£15.95
1.00mm cable, 5 metre	FL3100LSHF5/BBE	£20.41
1.00mm cable, 7 metre	FL3100LSHF7/BBE	£24.84

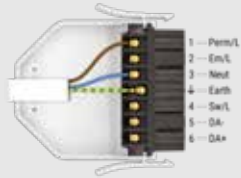
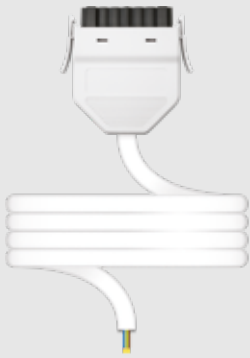

Permanent Supply Luminaire Leads, All White

- ▶ 3-core luminaire lead for use where each luminaire has an integral PIR, and no external Control Module is required.
- ▶ All luminaire leads in range are 100% tested, and come with ferruled conductors at free end.
- ▶ Compatible with all Distribution Boxes.
- ▶ Socket compatibility:

FTS03/W	✗	FTS04/W	✗	FTS05/W	✗	FTS06/W	✗	FTS07/W	✓
---------	---	---------	---	---------	---	---------	---	---------	---

DESCRIPTION	PART NO.	PRICE
0.75mm cable, 2 metre	FL375LSHF2/WP	£13.91
0.75mm cable, 3 metre	FL375LSHF3/WP	£15.87
0.75mm cable, 5 metre	FL375LSHF5/WP	£19.97
0.75mm cable, 7 metre	FL375LSHF7/WP	£23.90
1.00mm cable, 2 metre	FL3100LSHF2/WP	£14.65
1.00mm cable, 3 metre	FL3100LSHF3/WP	£17.03
1.00mm cable, 5 metre	FL3100LSHF5/WP	£21.46
1.00mm cable, 7 metre	FL3100LSHF7/WP	£26.06
1.50mm cable, 2 metre	FL3150LSHF2/WP	£16.23
1.50mm cable, 3 metre	FL3150LSHF3/WP	£19.35
1.50mm cable, 5 metre	FL3150LSHF5/WP	£25.13
1.50mm cable, 7 metre	FL3150LSHF7/WP	£31.06



Permanent Supply Luminaire Leads, All Black

- ▶ 3-core luminaire lead for use where each luminaire has an integral PIR, and no external Control Module is required.
- ▶ All luminaire leads in range are 100% tested, and come with ferruled conductors at free end.
- ▶ Compatible with all Distribution Boxes.
- ▶ Socket compatibility:

FTS03/W	✗	FTS04/W	✗	FTS05/W	✗	FTS06/W	✗	FTS07/W	✓
---------	---	---------	---	---------	---	---------	---	---------	---

DESCRIPTION	PART NO.	PRICE
1.00mm cable, 2 metre	FL3100LSHF2/BBP	£15.85
1.00mm cable, 3 metre	FL3100LSHF3/BBP	£18.04
1.00mm cable, 5 metre	FL3100LSHF5/BBP	£22.50
1.00mm cable, 7 metre	FL3100LSHF7/BBP	£26.93

DALI and DALI + Maintained Emergency Luminaire Leads

Use with luminaires that are controlled solely by a DALI signal (or similar protocol) and as such do not require mains rated switched live.

Luminaire leads ending 'D' derive their permanent supply separately to the emergency supply (non-emergency luminaires remain operational during an emergency test).

Non-associative colours, and other cable lengths may be available to special order. Please phone us on 020 8580 1066 for part numbers or advice.



DALI Luminaire Leads, Black With White Cable

- ▶ 5-core luminaire lead for use with luminaire controlled by DALI (or similar) protocol.
- ▶ Permanent Live on Pin 1.
- ▶ This luminaire lead has no switched live.
- ▶ All luminaire leads in range are 100% tested and come with ferruled conductors at free end.
- ▶ Non-emergency luminaires remain operational during emergency test.
- ▶ Compatible with all Distribution Boxes.
- ▶ Socket compatibility: FTS03/B ✗ FTS04/B ✗ FTS05/B ✗ FTS06/B ✗ FTS07/B ✓

DESCRIPTION	PART NO.	PRICE
0.75mm cable, 2 metre	FL575LSHF2/BD	£17.57
0.75mm cable, 3 metre	FL575LSHF3/BD	£20.80
0.75mm cable, 5 metre	FL575LSHF5/BD	£27.39
0.75mm cable, 7 metre	FL575LSHF7/BD	£33.63
1.00mm cable, 2 metre	FL5100LSHF2/BD	£18.56
1.00mm cable, 3 metre	FL5100LSHF3/BD	£22.27
1.00mm cable, 5 metre	FL5100LSHF5/BD	£29.66
1.00mm cable, 7 metre	FL5100LSHF7/BD	£36.71
1.50mm cable, 2 metre	FL5150LSHF2/BD	£21.21
1.50mm cable, 3 metre	FL5150LSHF3/BD	£26.12
1.50mm cable, 5 metre	FL5150LSHF5/BD	£35.79
1.50mm cable, 7 metre	FL5150LSHF7/BD	£45.06



DALI Luminaire Leads, All Black

- ▶ 5-core luminaire lead for use with luminaire controlled by DALI (or similar) protocol.
- ▶ Permanent Live on Pin 1.
- ▶ This luminaire lead has no switched live.
- ▶ All luminaire leads in range are 100% tested and come with ferruled conductors at free end.
- ▶ Non-emergency luminaires remain operational during emergency test.
- ▶ Compatible with all Distribution Boxes.
- ▶ Socket compatibility:

FTS03/B	✗	FTS04/B	✗	FTS05/B	✗	FTS06/B	✗	FTS07/B	✓
---------	---	---------	---	---------	---	---------	---	---------	---



DESCRIPTION	PART NO.	PRICE
1.00mm cable, 2 metre	FL5100LSHF2/BBD	£20.84
1.00mm cable, 3 metre	FL5100LSHF3/BBD	£24.92
1.00mm cable, 5 metre	FL5100LSHF5/BBD	£33.04
1.00mm cable, 7 metre	FL5100LSHF7/BBD	£41.19



DALI + Maintained Emergency Luminaire Leads, Red With White Cable

- ▶ 6-core luminaire lead for use with luminaire or maintained emergency luminaire controlled by DALI (or similar) protocol.
- ▶ Permanent Live on Pin 1.
- ▶ This luminaire lead has no switched live.
- ▶ All luminaire leads in range are 100% tested and come with ferruled conductors at free end.
- ▶ Non-emergency luminaires remain operational during emergency test.
- ▶ Compatible with all Distribution Boxes.
- ▶ Socket compatibility:

FTS03/R	✗	FTS04/R	✗	FTS05/R	✗	FTS06/R	✗	FTS07/R	✓
---------	---	---------	---	---------	---	---------	---	---------	---

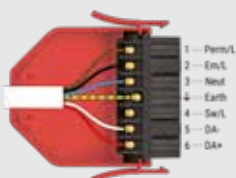

DESCRIPTION	PART NO.	PRICE
0.75mm cable, 2 metre	FL675LSHF2/RD	£21.31
0.75mm cable, 3 metre	FL675LSHF3/RD	£25.84
0.75mm cable, 5 metre	FL675LSHF5/RD	£35.46
0.75mm cable, 7 metre	FL675LSHF7/RD	£44.14
1.00mm cable, 2 metre	FL6100LSHF2/RD	£22.20
1.00mm cable, 3 metre	FL6100LSHF3/RD	£27.04
1.00mm cable, 5 metre	FL6100LSHF5/RD	£36.67
1.00mm cable, 7 metre	FL6100LSHF7/RD	£46.76
1.50mm cable, 2 metre	FL6150LSHF2/RD	£25.13
1.50mm cable, 3 metre	FL6150LSHF3/RD	£31.11
1.50mm cable, 5 metre	FL6150LSHF5/RD	£43.61
1.50mm cable, 7 metre	FL6150LSHF7/RD	£54.91

DALI + Maintained Emergency Luminaire Leads, All Black



- ▶ 6-core luminaire lead for use with luminaire or maintained emergency luminaire controlled by DALI (or similar) protocol.
- ▶ Permanent Live on Pin 1.
- ▶ This luminaire lead has no switched live.
- ▶ All luminaire leads in range are 100% tested and come with ferruled conductors at free end.
- ▶ Non-emergency luminaires remain operational during emergency test.
- ▶ Compatible with all Distribution Boxes.
- ▶ Socket compatibility:

FTS03/R	✘	FTS04/R	✘	FTS05/R	✘	FTS06/R	✘	FTS07/R	✔
---------	---	---------	---	---------	---	---------	---	---------	---

DESCRIPTION	PART NO.	PRICE
1.00mm cable, 2 metre	FL6100LSHF2/BBD	£23.71
1.00mm cable, 3 metre	FL6100LSHF3/BBD	£28.87
1.00mm cable, 5 metre	FL6100LSHF5/BBD	£39.18
1.00mm cable, 7 metre	FL6100LSHF7/BBD	£49.37

Cable Mount Sockets

Available in white, red, black, or grey, flex7 Cable Mount Sockets are robust and simple to use. In-line terminals, and a pair of screws which both secure the cover and clamp the flexible cable, make it quick and easy to wire.

Cable Mount Sockets are generally used in the preparation of Extender Leads where they are fitted to one end of a cable whilst the other end is fitted with a matching plug.



3-Pole Cable Mount Socket

- ▶ Use with standard (on/off) luminaires.



DESCRIPTION	PART NO.	PRICE
White 3-pole cable mount socket (Box of 10, unwired)	FS3/W	£8.12 EA.
Red 3-pole cable mount socket (Box of 10, unwired)	FS3/R	£8.12 EA.
Black 3-pole cable mount socket (Box of 10, unwired)	FS3/B	£8.12 EA.
Grey 3-pole cable mount socket (Box of 10, unwired)	FS3/G	£8.12 EA.

4-Pole Cable Mount Socket

- ▶ Use with standard (on/off) + emergency luminaires.

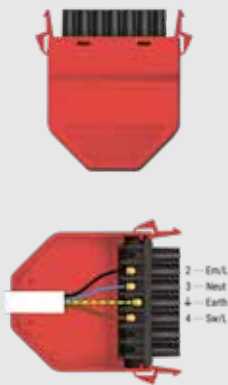

DESCRIPTION	PART NO.	PRICE
Red 4-pole cable mount socket (Box of 10, unwired)	FS4/R	£9.38 EA.
White 4-pole cable mount socket (Box of 10, unwired)	FS4/W	£9.38 EA.
Black 4-pole cable mount socket (Box of 10, unwired)	FS4/B	£9.38 EA.
Grey 4-pole cable mount socket (Box of 10, unwired)	FS4/G	£9.38 EA.

7-Pole Cable Mount Socket

- ▶ Use with dimmable luminaires.



DESCRIPTION	PART NO.	PRICE
Black 7-pole cable mount socket (Box of 10, unwired)	FS7/B	£12.75 EA.
White 7-pole cable mount socket (Box of 10, unwired)	FS7/W	£12.75 EA.
Red 7-pole cable mount socket (Box of 10, unwired)	FS7/R	£12.75 EA.
Grey 7-pole cable mount socket (Box of 10, unwired)	FS7/G	£12.75 EA.

Extender and Double Extender Leads

Use Extender Leads to cover the distance between a short Luminaire Lead, Distribution Box, or supply socket.

Using one means luminaires can be wired up with a short lead, pre-installation. Ideal when the luminaire manufacturer is fitting the lead.

Another advantage is that it provides a means of disconnection very close to the luminaire, as well as at the Distribution Box further away.

The Double Extender Lead has the added benefit of an extra socket set at a right angle to the inline socket.

The right angled socket can be used to plug into a local luminaire, while the inline socket continues the circuit to the next fitting.

This solution is particularly useful where luminaires are sited in rows, such as corridors and open plan offices, or where specification calls for a means of disconnection close to the luminaire.

Additionally, unlike similar systems, any luminaire in the row can be unplugged without affecting any of the others.

Non-associative colours, and other cable lengths may be available to special order (Extender Lead only). Please phone us on 020 8580 1066 for part numbers.



Extender Leads

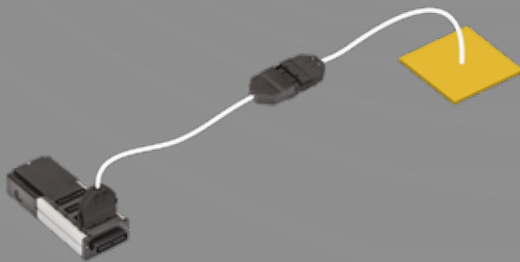

Double Extender Leads

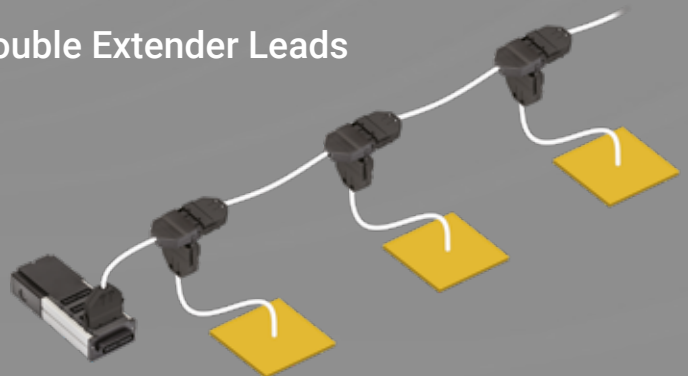

Mounting Brackets

Mounting brackets are available to support the sockets. The metal 'clip-in' mechanism is a simple solution to ensure compliance with BS7671 521.10.202.

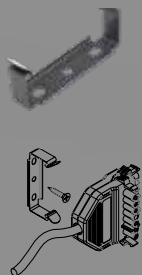



Mounting Bracket

- ▶ Use to support Extender and Double Extender Lead Sockets

DESCRIPTION	PART NO.	PRICE
Mounting Bracket	FB009	£1.67

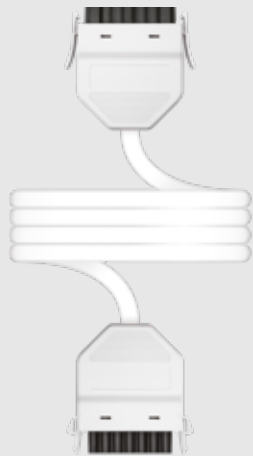

Standard Extender Leads, All White

- ▶ 3-core Extender Lead for use with standard (on/off) luminaires.
- ▶ All Extender Leads in the range are 100% tested.

DESCRIPTION	PART NO.	PRICE
1.00mm cable, 2 metre	FS3100LSHF2/W	£20.80
1.00mm cable, 3 metre	FS3100LSHF3/W	£22.89
1.00mm cable, 5 metre	FS3100LSHF5/W	£27.35
1.00mm cable, 7 metre	FS3100LSHF7/W	£31.17
1.50mm cable, 2 metre	FS3150LSHF2/W	£22.09
1.50mm cable, 3 metre	FS3150LSHF3/W	£24.96
1.50mm cable, 5 metre	FS3150LSHF5/W	£30.83
1.50mm cable, 7 metre	FS3150LSHF7/W	£35.94



Standard Extender Leads, All Black

- ▶ 3-core Extender Lead for use with standard (on/off) luminaires.
- ▶ All Extender Leads in the range are 100% tested.

DESCRIPTION	PART NO.	PRICE
1.00mm cable, 2 metre	FS3100LSHF2/BB	£22.81
1.00mm cable, 3 metre	FS3100LSHF3/BB	£25.00
1.00mm cable, 5 metre	FS3100LSHF5/BB	£29.46
1.00mm cable, 7 metre	FS3100LSHF7/BB	£33.89

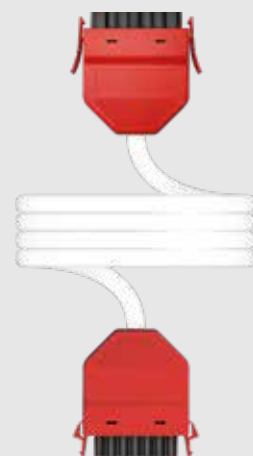

Maintained Emergency Extender Leads, Red With White Cable

- ▶ 4-core Extender Lead for use with standard (on/off) + maintained emergency luminaires.
- ▶ All Extender Leads in the range are 100% tested.

DESCRIPTION	PART NO.	PRICE
1.00mm cable, 2 metre	FS4100LSHF2/R	£24.63
1.00mm cable, 3 metre	FS4100LSHF3/R	£27.46
1.00mm cable, 5 metre	FS4100LSHF5/R	£33.27
1.00mm cable, 7 metre	FS4100LSHF7/R	£39.04
1.50mm cable, 2 metre	FS4150LSHF2/R	£26.51
1.50mm cable, 3 metre	FS4150LSHF3/R	£30.39
1.50mm cable, 5 metre	FS4150LSHF5/R	£38.09
1.50mm cable, 7 metre	FS4150LSHF7/R	£45.68



Maintained Emergency Extender Leads, All Black

- ▶ 4-core Extender Lead for use with standard (on/off) + maintained emergency luminaires.
- ▶ All Extender Leads in the range are 100% tested.

DESCRIPTION	PART NO.	PRICE
1.00mm cable, 2 metre	FS4100LSHF2/BB	£26.96
1.00mm cable, 3 metre	FS4100LSHF3/BB	£29.99
1.00mm cable, 5 metre	FS4100LSHF5/BB	£36.06
1.00mm cable, 7 metre	FS4100LSHF7/BB	£42.09

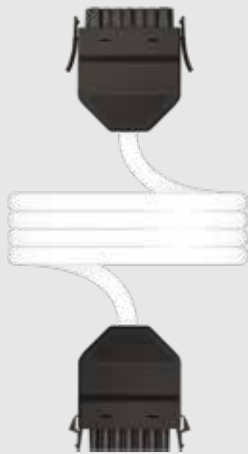

Dimmable Extender Leads, Black With White Cable

- ▶ 5-core Extender Lead for use with dimmable luminaires.
- ▶ All Extender Leads in the range are 100% tested.

DESCRIPTION	PART NO.	PRICE
1.00mm cable, 2 metre	FS5100LSHF2/B	£28.96
1.00mm cable, 3 metre	FS5100LSHF3/B	£32.37
1.00mm cable, 5 metre	FS5100LSHF5/B	£39.39
1.00mm cable, 7 metre	FS5100LSHF7/B	£46.31
1.50mm cable, 2 metre	FS5150LSHF2/B	£31.94
1.50mm cable, 3 metre	FS5150LSHF3/B	£35.92
1.50mm cable, 5 metre	FS5150LSHF5/B	£45.35
1.50mm cable, 7 metre	FS5150LSHF7/B	£54.55



Dimmable Extender Leads, All Black

- ▶ 5-core Extender Lead for use with dimmable luminaires.
- ▶ All Extender Leads in the range are 100% tested.

DESCRIPTION	PART NO.	PRICE
1.00mm cable, 2 metre	FS5100LSHF2/BB	£32.74
1.00mm cable, 3 metre	FS5100LSHF3/BB	£36.82
1.00mm cable, 5 metre	FS5100LSHF5/BB	£44.94
1.00mm cable, 7 metre	FS5100LSHF7/BB	£53.09

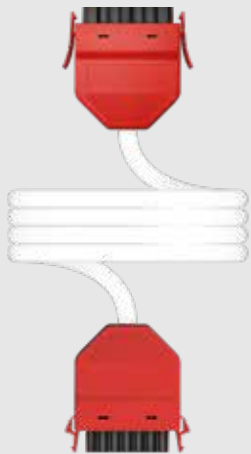

Dimmable Maintained Emergency Extender Leads, Red With White Cable

- ▶ 6-core Extender Lead for use with dimmable + maintained emergency luminaires.
- ▶ All Extender Leads in the range are 100% tested.

DESCRIPTION	PART NO.	PRICE
1.00mm cable, 2 metre	FS6100LSHF2/R	£33.83
1.00mm cable, 3 metre	FS6100LSHF3/R	£39.10
1.00mm cable, 5 metre	FS6100LSHF5/R	£48.32
1.00mm cable, 7 metre	FS6100LSHF7/R	£57.36
1.50mm cable, 2 metre	FS6150LSHF2/R	£37.55
1.50mm cable, 3 metre	FS6150LSHF3/R	£43.22
1.50mm cable, 5 metre	FS6150LSHF5/R	£54.54
1.50mm cable, 7 metre	FS6150LSHF7/R	£65.57



Dimmable Maintained Emergency Extender Leads, All Black

- ▶ 6-core Extender Lead for use with dimmable + maintained emergency luminaires.
- ▶ All Extender Leads in the range are 100% tested.

DESCRIPTION	PART NO.	PRICE
1.00mm cable, 2 metre	FS6100LSHF2/BB	£37.63
1.00mm cable, 3 metre	FS6100LSHF3/BB	£42.79
1.00mm cable, 5 metre	FS6100LSHF5/BB	£53.10
1.00mm cable, 7 metre	FS6100LSHF7/BB	£63.29

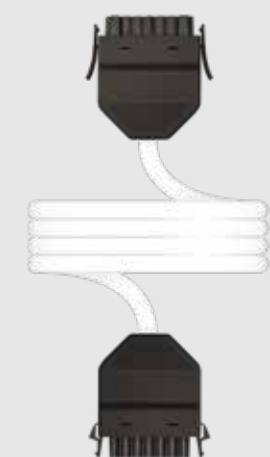

Extender Leads For Special Applications, Black With White Cable

- ▶ 7-core Extender Lead for use with bespoke luminaires eg. luminaires that have multiple switch lives.
- ▶ All Extender Leads in the range are 100% tested.

DESCRIPTION	PART NO.	PRICE
1.00mm cable, 2 metre	FS7100LSHF2/B	£37.07
1.00mm cable, 3 metre	FS7100LSHF3/B	£42.88
1.00mm cable, 5 metre	FS7100LSHF5/B	£53.04
1.00mm cable, 7 metre	FS7100LSHF7/B	£62.96
1.50mm cable, 2 metre	FS7150LSHF2/B	£42.11
1.50mm cable, 3 metre	FS7150LSHF3/B	£48.91
1.50mm cable, 5 metre	FS7150LSHF5/B	£62.55
1.50mm cable, 7 metre	FS7100LSHF7/B	£77.28



Extender Leads For Special Applications, All Black

- ▶ 7-core Extender Lead for use with bespoke luminaires eg. luminaires that have multiple switch lives.
- ▶ All Extender Leads in the range are 100% tested.

DESCRIPTION	PART NO.	PRICE
1.00mm cable, 2 metre	FS7100LSHF2/BB	£41.60
1.00mm cable, 3 metre	FS7100LSHF3/BB	£47.42
1.00mm cable, 5 metre	FS7100LSHF5/BB	£59.07
1.00mm cable, 7 metre	FS7100LSHF7/BB	£70.61

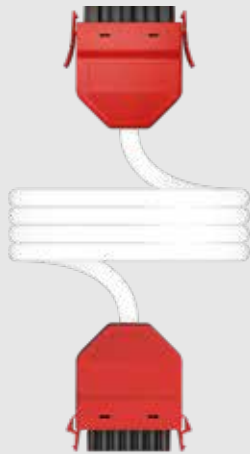

Non-maintained Emergency Extender Leads, Red With White Cable

- ▶ 3-core Extender Lead for use with non-maintained, emergency luminaires.
- ▶ All Extender Leads in the range are 100% tested.

DESCRIPTION	PART NO.	PRICE
1.00mm cable, 2 metre	FS3100LSHF2/RE	£22.51
1.00mm cable, 3 metre	FS3100LSHF3/RE	£24.66
1.00mm cable, 5 metre	FS3100LSHF5/RE	£29.27
1.00mm cable, 7 metre	FS3100LSHF7/RE	£33.86
1.50mm cable, 2 metre	FS3150LSHF2/RE	£24.36
1.50mm cable, 3 metre	FS3150LSHF3/RE	£26.78
1.50mm cable, 5 metre	FS3150LSHF5/RE	£32.87
1.50mm cable, 7 metre	FS3150LSHF7/RE	£38.87



Non-maintained Emergency Extender Leads, All Black

- ▶ 3-core Extender Lead for use with non-maintained, emergency luminaires.
- ▶ All Extender Leads in the range are 100% tested.

DESCRIPTION	PART NO.	PRICE
1.00mm cable, 2 metre	FS3100LSHF2/BBE	£24.78
1.00mm cable, 3 metre	FS3100LSHF3/BBE	£26.97
1.00mm cable, 5 metre	FS3100LSHF5/BBE	£31.43
1.00mm cable, 7 metre	FS3100LSHF7/BBE	£35.86

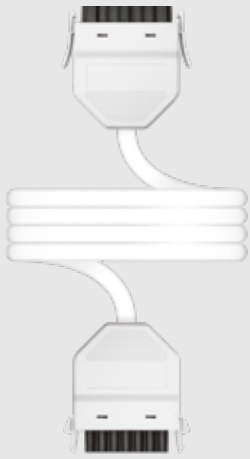

Permanent Supply Extender Leads, All White

- ▶ 3-core Extender Lead for use where each luminaire has an integral PIR, and no external Control Module is required.
- ▶ All Extender Leads in range are 100% tested.

DESCRIPTION	PART NO.	PRICE
1.00mm cable, 2 metre	FS3100LSHF2/WP	£24.28
1.00mm cable, 3 metre	FS3100LSHF3/WP	£26.39
1.00mm cable, 5 metre	FS3100LSHF5/WP	£31.62
1.00mm cable, 7 metre	FS3100LSHF7/WP	£35.55
1.50mm cable, 2 metre	FS3150LSHF2/WP	£26.12
1.50mm cable, 3 metre	FS3150LSHF3/WP	£29.09
1.50mm cable, 5 metre	FS3150LSHF5/WP	£35.25
1.50mm cable, 7 metre	FS3150LSHF7/WP	£40.57



Permanent Supply Extender Leads, All Black

- ▶ 3-core Extender Lead for use where each luminaire has an integral PIR, and no external Control Module is required.
- ▶ All Extender Leads in range are 100% tested.

DESCRIPTION	PART NO.	PRICE
1.00mm cable, 2 metre	FS3100LSHF2/BBP	£27.21
1.00mm cable, 3 metre	FS3100LSHF3/BBP	£29.40
1.00mm cable, 5 metre	FS3100LSHF5/BBP	£33.86
1.00mm cable, 7 metre	FS3100LSHF7/BBP	£38.29

DALI and DALI + Maintained Emergency Extender Leads

Use with luminaires that are controlled solely by a DALI signal (or similar protocol) and as such do not require mains rated switched live.

Extender Leads ending 'D' derive their permanent supply separately to the emergency supply (non-emergency luminaires remain operational during an emergency test).

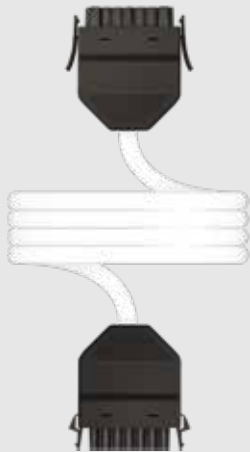

DALI Extender Leads, Black With White Cable

- ▶ 5-core Extender Lead for use with luminaires controlled by DALI (or similar) protocol.
- ▶ Permanent Live on Pin 1
- ▶ This Extender Lead has no switched live.
- ▶ All Extender Leads in the range are 100% tested, and come with ferruled conductors at free end.
- ▶ Non-emergency luminaires remain operational during emergency test.

DESCRIPTION	PART NO.	PRICE
1.00mm cable, 2 metre	FS5100LSHF2/BD	£31.43
1.00mm cable, 3 metre	FS5100LSHF3/BD	£34.90
1.00mm cable, 5 metre	FS5100LSHF5/BD	£43.02
1.00mm cable, 7 metre	FS5100LSHF7/BD	£50.27
1.50mm cable, 2 metre	FS5150LSHF2/BD	£34.52
1.50mm cable, 3 metre	FS5150LSHF3/BD	£39.39
1.50mm cable, 5 metre	FS5150LSHF5/BD	£49.26
1.50mm cable, 7 metre	FS5150LSHF7/BD	£58.89



DALI Extender Leads, All Black

- ▶ 5-core Extender Lead for use with luminaires controlled by DALI (or similar) protocol.
- ▶ Permanent Live on Pin 1
- ▶ This Extender Lead has no switched live.
- ▶ All Extender Leads in the range are 100% tested, and come with ferruled conductors at free end.
- ▶ Non-emergency luminaires remain operational during emergency test.

DESCRIPTION	PART NO.	PRICE
1.00mm cable, 2 metre	FS5100LSHF2/BBD	£35.14
1.00mm cable, 3 metre	FS5100LSHF3/BBD	£39.22
1.00mm cable, 5 metre	FS5100LSHF5/BBD	£47.34
1.00mm cable, 7 metre	FS5100LSHF7/BBD	£55.49

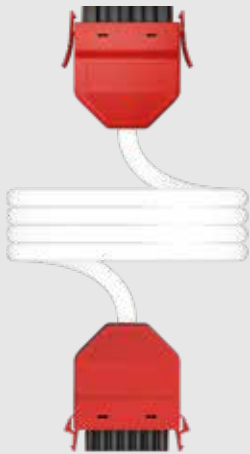

DALI + Maintained Emergency Extender Leads, Red With White Cable

- ▶ 6-core Extender Lead for use with luminaires controlled by DALI (or similar) protocol with maintained emergency function.
- ▶ Permanent Live on Pin 1
- ▶ This Extender Lead has no switched live.
- ▶ All Extender Leads in the range are 100% tested, and come with ferruled conductors at free end.
- ▶ Non-emergency luminaires remain operational during emergency test.

DESCRIPTION	PART NO.	PRICE
1.00mm cable, 2 metre	FS6100LSHF2/RD	£34.02
1.00mm cable, 3 metre	FS6100LSHF3/RD	£38.92
1.00mm cable, 5 metre	FS6100LSHF5/RD	£48.79
1.00mm cable, 7 metre	FS6100LSHF7/RD	£58.47
1.50mm cable, 2 metre	FS6150LSHF2/RD	£36.50
1.50mm cable, 3 metre	FS6150LSHF3/RD	£42.33
1.50mm cable, 5 metre	FS6150LSHF5/RD	£58.38
1.50mm cable, 7 metre	FS6150LSHF7/RD	£70.75



DALI + Maintained Emergency Extender Leads, All Black

- ▶ Live on Pin 1
- ▶ 6-core Extender Lead for use with luminaires controlled by DALI (or similar) protocol with maintained emergency function.
- ▶ All Extender Leads in the range are 100% tested, and come with ferruled conductors at free end.
- ▶ This Extender Lead has no switched live.
- ▶ Non-emergency luminaires remain operational during emergency test.

DESCRIPTION	PART NO.	PRICE
1.00mm cable, 2 metre	FS6100LSHF2/BBD	£39.52
1.00mm cable, 3 metre	FS6100LSHF3/BBD	£44.68
1.00mm cable, 5 metre	FS6100LSHF5/BBD	£54.99
1.00mm cable, 7 metre	FS6100LSHF7/BBD	£65.18

Double Extender Leads

Use where luminaires are sited in rows, such as corridors or open plan offices, or where specification calls for a means of disconnection close to the luminaires.

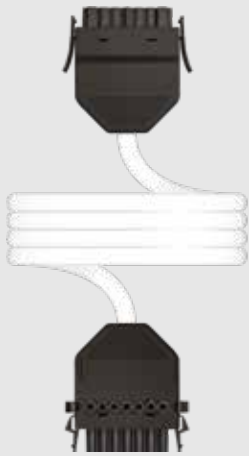

Standard (on/off) Double Extender Leads, Black With White Cable

- ▶ 3-core Double Extender Leads for use with standard (on/off) luminaires.
- ▶ All Double Extender Leads in the range are 100% tested.

DESCRIPTION	PART NO.	PRICE
1.50mm cable, 2 metre	FD3150LSHF2/B	£26.15
1.50mm cable, 3 metre	FD3150LSHF3/B	£28.40
1.50mm cable, 5 metre	FD3150LSHF5/B	£34.30
1.50mm cable, 7 metre	FD3150LSHF7/B	£39.41

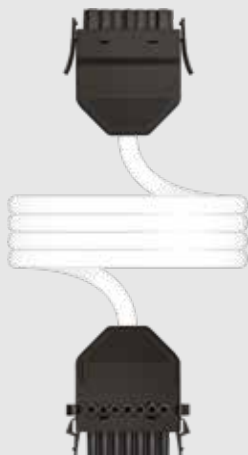

Maintained Emergency Double Extender Leads, Black With White Cable

- ▶ 4-core Double Extender Lead for use with standard (on/off) + maintained emergency luminaires.
- ▶ All Double Extender Leads in the range are 100% tested.

DESCRIPTION	PART NO.	PRICE
1.50mm cable, 2 metre	FD4150LSHF2/B	£31.61
1.50mm cable, 3 metre	FD4150LSHF3/B	£34.76
1.50mm cable, 5 metre	FD4150LSHF5/B	£42.53
1.50mm cable, 7 metre	FD4150LSHF7/B	£50.22

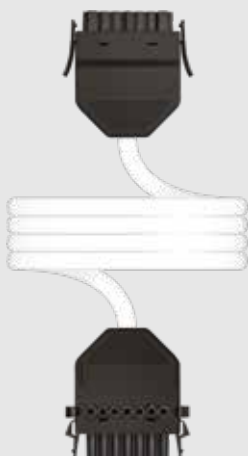

Dimmable Double Extender Leads, Black With White Cable

- ▶ 5-core Double Extender Lead for use with dimmable luminaires.
- ▶ All Double Extender Leads in the range are 100% tested.

DESCRIPTION	PART NO.	PRICE
1.50mm cable, 2 metre	FD5150LSHF2/B	£35.83
1.50mm cable, 3 metre	FD5150LSHF3/B	£40.41
1.50mm cable, 5 metre	FD5150LSHF5/B	£49.76
1.50mm cable, 7 metre	FD5150LSHF7/B	£58.96

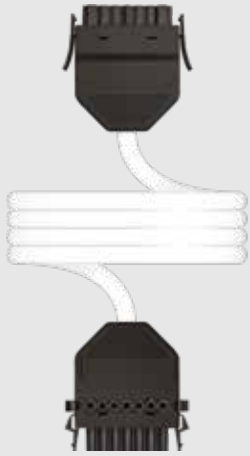

Dimmable Maintained Emergency Double Extender Leads, Black With White Cable

- ▶ 6-core Double Extender Lead for use with dimmable + maintained emergency luminaires.
- ▶ All Double Extender Leads in the range are 100% tested.

DESCRIPTION	PART NO.	PRICE
1.50mm cable, 2 metre	FD6150LSHF2/B	£42.26
1.50mm cable, 3 metre	FD6150LSHF3/B	£47.73
1.50mm cable, 5 metre	FD6150LSHF5/B	£59.99
1.50mm cable, 7 metre	FD6150LSHF7/B	£71.03

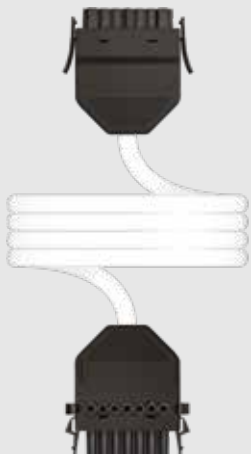

Double Extender Leads For Special Applications, Black With White Cable

- ▶ 7-core Double Extender Lead for use with bespoke luminaires eg. luminaires that have multiple switch lives.
- ▶ All Double Extender Leads in the range are 100% tested.

DESCRIPTION	PART NO.	PRICE
1.50mm cable, 2 metre	FD7150LSHF2/B	£48.52
1.50mm cable, 3 metre	FD7150LSHF3/B	£55.19
1.50mm cable, 5 metre	FD7150LSHF5/B	£68.71
1.50mm cable, 7 metre	FD7150LSHF7/B	£83.63

DALI and DALI + Maintained Emergency Double Extender Leads

Use with luminaires that are controlled solely by a DALI signal (or similar protocol) and as such do not require mains rated switched live.

Double Extender Leads ending 'D' derive their permanent supply separately to the emergency supply (non-emergency luminaires remain operational during an emergency test).

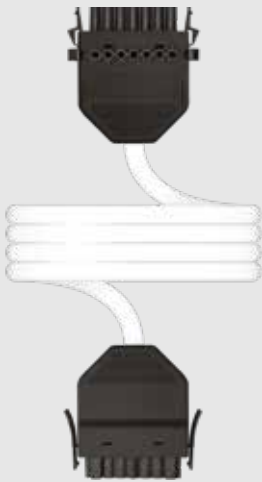

DALI Double Extender Leads, Black With White Cable

- ▶ 5-core Double Extender Lead for use with luminaires controlled by DALI (or similar) protocol.
- ▶ Permanent Live on pin 1.
- ▶ This Double Extender Lead has no switched live.
- ▶ All Double Extender Leads in the range are 100% tested.
- ▶ Non-emergency luminaires remain operational during emergency test.

DESCRIPTION	PART NO.	PRICE
1.50mm cable, 2 metre	FD5150LSHF2/BD	£39.52
1.50mm cable, 3 metre	FD5150LSHF3/BD	£44.28
1.50mm cable, 5 metre	FD5150LSHF5/BD	£54.03
1.50mm cable, 7 metre	FD5150LSHF7/BD	£63.68

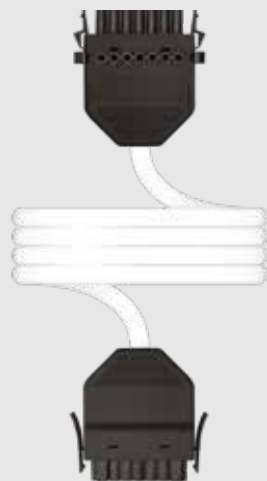

DALI + Maintained Emergency Double Extender Leads, Black With White Cable

- ▶ 6-core Double Extender Lead for use with luminaires controlled by DALI (or similar) protocol with maintained emergency function.
- ▶ Permanent Live on pin 1.
- ▶ This Double Extender Lead has no switched live.
- ▶ All Double Extender Leads in the range are 100% tested.
- ▶ Non-emergency luminaires remain operational during emergency test.

DESCRIPTION	PART NO.	PRICE
1.50mm cable, 2 metre	FD6150LSHF2/BD	£45.00
1.50mm cable, 3 metre	FD6150LSHF3/BD	£51.80
1.50mm cable, 5 metre	FD6150LSHF5/BD	£63.35
1.50mm cable, 7 metre	FD6150LSHF7/BD	£76.37

flex7 Lighting Controls

Up to 60% of the energy used by lighting can be saved if manual switching is replaced by automatic lighting control. Using flex7 makes it easy to select and install the controls you need to achieve these savings. Our lighting controls simply plug into any of our Distribution Boxes, providing quick and hassle-free installation and maintenance.



- Occupancy, absence, daylight dependency and daylight linking
- Integrated emergency test
- Corridor hold
- Last man out switch
- Networking across circuits/phases

Simple plug-in connection.

Small Sensor Head (32mmØ cutout).

RJ Connectivity.

Easy for installer to commission.

Protected Extra Low Voltage.



How to order flex7 Lighting Controls

Our lighting controls are entirely modular, and comprise a Sensor Head, a Control Module and a Sensor Lead to plug the head into the Control Module:



Sensor Heads

We offer both PIR (Passive Infrared) and Microwave Sensor Heads. Both versions are available with occupancy, and daylight sensing. IP67 and Surface mount / Tamper resistant versions of our PIR Sensor Head are also available. Simply choose the type of head you require from the Sensor Head section.



Control Modules

We have a wide range of Control Modules available: Occupancy, absence, dimming, non-dimming. Whichever option you choose, it will plug directly into any flex7 lighting Distribution Box.

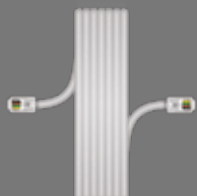

Sensor Leads

A Sensor Lead is needed to plug your Sensor Head into your Control Module. These come in a variety of lengths.



Occupancy Sensors

Turn lights on when someone enters a room and turn off again once the room has been empty for a set period of time. Timeout is set to 20 minutes by default, but this can be adjusted using a Setup Remote Control.



Absence Sensors

Lights need to be switched on manually at the switch when entering a room, but will turn off automatically once the room has been empty for a set period of time. This option gives users a higher level of control, and has extra potential for energy saving, as the user will only turn lights on if they need them. Timeout is set to 20 minutes by default, but this can be adjusted using a Setup Remote Control.



Daylight Dependent Sensors

Turn lights off when there is sufficient natural light in the room. Timeout is set to 20 minutes by default, but this can be adjusted using a Setup Remote Control.



Daylight Linking Sensors

Dim lights down when there is sufficient natural light in the room. Timeout is set to 20 minutes by default, but this can be adjusted using a Setup Remote Control.

PIR Sensors

Passive Infrared (PIR) Sensors detect a body of heat moving across the area they are monitoring.



Pros

- Very precise over smaller areas.
- Less prone to false triggering.
- Cost-effective option.

Cons

- Must be installed in the right position to provide optimum coverage.

Ideal for use in:

- Most areas except where extreme temperatures (high/low) may be present.

Microwave Sensors

Microwave Sensors emit microwave signals and measure the reflection from surfaces and objects within the area they are monitoring.



Pros

- Long detection range.
- Can be installed in areas with temperature extremes eg. +40°C, -20°C
- Line of site not necessary.

Cons

- Can 'see' through walls and glass, so can be falsely triggered by movement outside the intended detection area.
- Can be falsely triggered by movements from inanimate objects (eg. passing cars or blowing trees).

Ideal for use in:

- Areas with movable partitions (eg. half height or modesty panels) or irregular shaped rooms.
- Corridors.

PIR Sensor Heads

PIR Sensor Heads need to be used in conjunction with a Control Module. A Sensor Lead is needed to connect the Sensor Head to a Control Module.

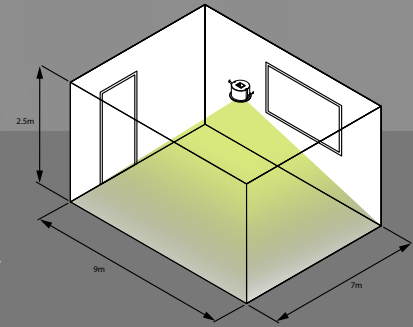

PIR Detection Pattern

The PIR (Passive Infrared) Sensor detects moving bodies of heat that are different (warmer or cooler) to the background temperature. The detection pattern is broadly rectangular at 9m x 7m when fixed at a ceiling height of 2.5m (longest length of detection aligns with the spring fixing clips).



PIR Absence/Occupancy & Light Level Sensor Head (Primary)

- ▶ Use for occupancy or absence with daylight dependency/linking. If a target light level is set, the Sensor Head will monitor ambient light and turn on/off or dim/brighten luminaires as required. If no target level is set lights will remain at full brightness.
- ▶ The integral infra-red receiver accepts commands from either the Setup or User Remote Control. An LED provides indication of operation.
- ▶ Requires a Control Module and Sensor Lead to operate.

DESCRIPTION

PIR occupancy + light level sensor head, white	FNH400	£68.32
PIR occupancy + light level sensor head, black	FNH400/BK	£68.32

PART NO. PRICE



PIR Auxiliary Sensor Head

- ▶ Use to increase the area of detection. Up to 5 Auxiliary Heads can be used in conjunction with 1 'Primary' Head, effectively increasing detection range by 6-fold. Ideal for use in corridors or large/irregular shaped rooms.
- ▶ Can be used with PIR or Microwave Sensors (excl. 230V version)
- ▶ Supplied with a 'Y' adaptor to allow plug-in connection of 2 Sensor Leads (in/out).
- ▶ Requires a 'Primary' Sensor Head, Control Module and Sensor Lead to operate.

DESCRIPTION

PIR auxiliary sensor head, white	FNH/AUX	£64.90
PIR auxiliary sensor head, black	FNH/AUX/BK	£64.90

PART NO. PRICE

Surface Mount / Tamper Resistant PIR Sensor Heads

Using the 2 x M4 screws supplied, fix directly to a standard BESA box with 50.8mm fixing centres in surface mount installations. Alternatively, replace the M4 screws supplied with security type fixings and use in installations where resilience to unsolicited attempts to remove or tamper is paramount; public areas, prisons, secure units etc.



Surface Mount / Tamper Resistant PIR Absence/Occupancy & Light Level Sensor Head

- ▶ Use for occupancy or absence with daylight dependency/linking. If a target light level is set, the Sensor Head will monitor ambient light and turn on/off or dim/brighten luminaires as required. If no target level is set lights will remain at full brightness.
- ▶ The integral infra-red receiver accepts commands from either the Setup or User Remote Control. An LED provides indication of operation.
- ▶ Requires a Control Module and Sensor Lead to operate.

DESCRIPTION

DESCRIPTION	PART NO.	PRICE
Surface mount PIR occupancy + light level sensor head, white	FNH400/S	£114.58
Surface mount PIR occupancy + light level sensor head, black	FNH400/S/BK	£114.58

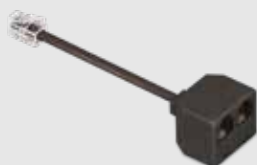

Surface Mount / Tamper Resistant Auxiliary PIR Sensor Head

- ▶ Use to increase the area of detection. Up to 5 Auxiliary Heads can be used in conjunction with 1 'Primary' Head, effectively increasing detection range by 6-fold. Ideal for use in corridors or large/irregular shaped rooms.
- ▶ Can be used with PIR or Microwave Sensors (excl. 230V version).
- ▶ Supplied with a 'Y' adaptor to allow plug-in connection of 2 Sensor Leads (in/out).
- ▶ Requires a 'Primary' Sensor Head, Control Module and Sensor Lead to operate.

DESCRIPTION

DESCRIPTION	PART NO.	PRICE
Surface mount auxiliary PIR sensor head, white	FNH/AUX/S	£106.35
Surface mount auxiliary PIR sensor head, black	FNH/AUX/S/BK	£106.35

IP67 PIR Sensor Heads

Use in external installations where protection from moisture is needed. Flush mount through a 34mm dia. hole into the ceiling, bulkhead, canopy etc. Sensor Head comes prewired with 5m lead.

Note: Control module is IP2X and must be installed in a suitable location.



IP67 PIR Absence/Occupancy & Light Level Sensor Head

- ▶ Use for occupancy or absence with daylight dependency/linking. If a target light level is set, the Sensor Head will monitor ambient light and turn on/off or dim/brighten luminaires as required. If no target level is set lights will remain at full brightness.
- ▶ The integral infra-red receiver accepts commands from either the Setup or User Remote Control. An LED provides indication of operation.
- ▶ Supplied complete with factory connected 5 metre Sensor Lead.
- ▶ Requires a Control Module to operate.

DESCRIPTION	PART NO.	PRICE
IP67 occupancy + light level sensing head, white	FNH400/IP67	£129.45
IP67 occupancy + light level sensing head, black	FNH400/IP67/BK	£129.45



IP67 Auxiliary PIR Sensor Head

- ▶ Use to increase the area of detection. Up to 5 Auxiliary Heads can be used in conjunction with 1 'Primary' Head, effectively increasing detection range by 6-fold. Ideal for use in corridors or large/irregular shaped rooms.
- ▶ Can be used with PIR or Microwave Sensors (excl. 230V version).
- ▶ Supplied with a 'Y' adaptor to allow plug-in connection of 2 Sensor Leads (in/out).
- ▶ Supplied complete with factory connected 5 metre Sensor Lead.

DESCRIPTION	PART NO.	PRICE
IP67 auxiliary sensor head, white	FNH/AUX/IP67	£123.03
IP67 auxiliary sensor head, black	FNH/AUX/IP67/BK	£123.03

Microwave Sensor Heads

The Microwave Sensor emits low powered signals which are reflected back off walls and other objects. A change of condition eg. someone entering the room changes the reflected signal, and the sensor detects this as presence. flex7 Microwave Sensors are available as a wall-mounted or ceiling-mounted option.

Wall-mounted Microwave detection pattern

The detection pattern is broadly rectangular at 25m x 6m when fixed at a height of 2.2m.

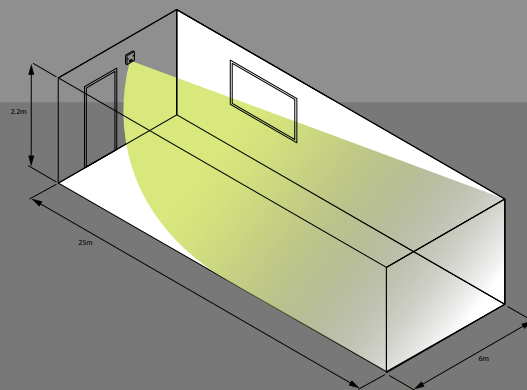

Ceiling-mounted Microwave detection pattern

The detection pattern is elliptical at 8m x 11m when fixed at a ceiling height of 2.5m.

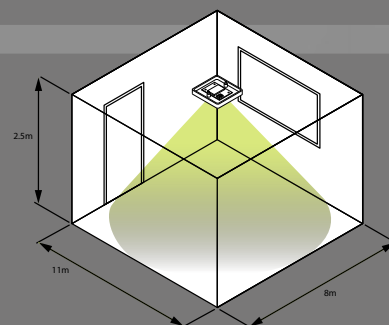

Microwave Absence/Occupancy & Light Level Microwave Sensor Head

- ▶ Use for occupancy or absence with daylight dependency/linking. If a target light level is set, the Sensor Head will monitor ambient light and turn on/off or dim/brighten luminaires as required. If no target level is set lights will remain at full brightness.
- ▶ The integral infrared receiver accepts commands from either the Setup or User Remote Control. An LED provides indication of operation.
- ▶ Requires a Control Module and Sensor Lead to operate.
- ▶ Use with 20mm single back box.

DESCRIPTION

Microwave occupancy + light level sensor head, ceiling-mounted

PART NO.

FMH400

PRICE

£85.05

Microwave occupancy + light level sensor head, wall-mounted

FMH400/W

£85.05

230V Mains Voltage Microwave Sensor Kit

The Microwave Sensor emits low powered signals which are reflected back off walls and other objects. A change of condition eg. someone entering the room changes the reflected signal, and the sensor detects this as presence. flex7 Microwave Sensors are available as a wall-mounted, or ceiling-mounted option.

Wall-mounted Microwave detection pattern

The detection pattern is broadly rectangular at 25m x 6m when fixed at a height of 2.2m.

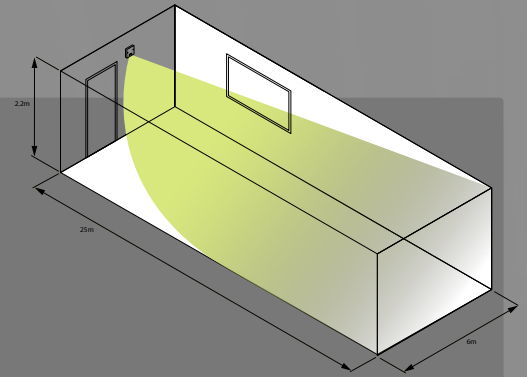

Ceiling-mounted Microwave detection pattern

The detection pattern is elliptical at 8m x 11m when fixed at a ceiling height of 2.5m.

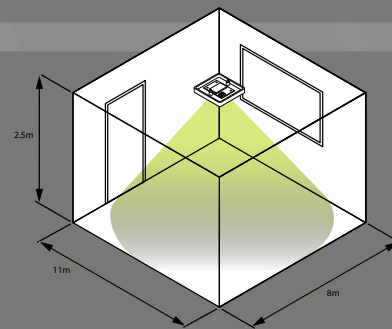

230V Mains Voltage Microwave Absence/Occupancy Sensor with Daylight Dependency

- ▶ Can be connected straight to mains (230V) supply.
- ▶ You can configure your sensor as either absence or occupancy:
- ▶ In Absence mode, luminaires need to be switched on manually on entry. They will switch off automatically if the room/area is vacated.
- ▶ In Occupancy mode, luminaires switch on automatically when movement is detected, and off when the room/area is vacated.
- ▶ Additionally, a target light level can be set, meaning luminaires switch off automatically when there is adequate ambient light. Typically this means luminaires are off during brighter periods of the day.
- ▶ Use with 45mm minimum single back box.
- ▶ Not suitable for dimming applications.

DESCRIPTION	PART NO.	PRICE
230V Microwave occupancy + light level sensor head, ceiling-mounted	FMH400/230	£136.82
230V Microwave occupancy + light level sensor head, wall-mounted	FMH400/W/230	£136.82



Sensor Leads

- ▶ Needed to connect all Sensor Heads (excl. 230V version) to a Control Module. Both ends are fitted with an RJ plug, for quick and easy plug-in connection.

DESCRIPTION	PART NO.	PRICE
Sensor lead, LSHF, 5 metre	FSL05	£9.70
Sensor lead, LSHF, 10 metre	FSL10	£15.96
Sensor lead, LSHF, 20 metre	FSL20	£27.14
Sensor lead, LSHF, 30 metre	FSL30	£41.16



Setup Remote Control

- ▶ Use to change timeout settings, light levels and other operational modes during commissioning.
- ▶ Note: Factory default for timeout is 20 mins.

DESCRIPTION	PART NO.	PRICE
Setup remote control	FRC/SET	£40.77



User Remote Control

- ▶ Use post installation to operate luminaires on/off and brighten/dim. Stores and recalls up to 6 configurable light levels.
- ▶ On/off and brighten/dim commands from FRC/USER are temporary, meaning the system reverts back to its commissioned state on time-out.
- ▶ Comes complete with wall holster and self-adhesive pads.
- ▶ Note: intended for end-user, not installer.

DESCRIPTION	PART NO.	PRICE
User remote control	FRC/USER	£40.77

Switch Drop Leads can be found on P.72

Individual Control Modules

Lighting Control Modules are available to purchase individually, as well as in kit form. This gives you the option to mix and match them with our range of Sensor Heads, Sensor Leads, Switch-Drop Leads, and Network Leads to create exactly what you need.



On/Off Control Module

- ▶ Use if luminaires require standard (on/off) control.
- ▶ Requires a Sensor Head and Sensor Lead, and/or Switch Drop Lead to operate.

DESCRIPTION	PART NO.	PRICE
On/Off control module	FNC1000/U	£63.05



Dimming Control Module

- ▶ Use if luminaires require dimming control.
- ▶ Requires a Sensor Head and Sensor Lead, and/or Switch Drop Lead to operate.
- ▶ Note: Analogue and DSI Control Modules are available on request.

DESCRIPTION	PART NO.	PRICE
DALI dimming control module	FNC3000X/U	£94.17

If using with a flex7 Switch please refer to 'Y' adaptors on page 72.

PIR Sensor Kits for Non-Dimming Applications

Series 1000 PIR Sensors - use for standard on/off control.

PIR Detection Pattern

The PIR (Passive Infrared) Sensor detects moving bodies of heat that are different (warmer or cooler) to the background temperature. The detection pattern is broadly rectangular at 9m x 7m when fixed at a ceiling height of 2.5m (longest length of detection aligns with the spring fixing clips).

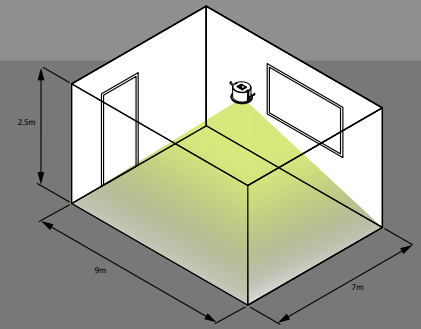

PIR Occupancy Sensor with Daylight Dependency

- ▶ Luminaires automatically switch on when movement is detected, and off when the room/area is vacated.
- ▶ Additionally, a target light level can be set, meaning luminaires switch off automatically when there is adequate ambient light. Typically this means luminaires are off during brighter periods of the day.
- ▶ Supplied with 5m Sensor Lead.
- ▶ Note: Remote control (FRC/SET) required to set target light level.

DESCRIPTION

PIR Occupancy sensor kit + daylight dependency

PART NO.

FNS1400

PRICE

£138.85



PIR Absence/Occupancy Sensor with Daylight Dependency

- ▶ You can configure this sensor as either absence or occupancy:
- ▶ In Absence mode, luminaires need to be switched on manually on entry. They will switch off automatically if the room/area is vacated.
- ▶ In Occupancy mode, luminaires switch on automatically when movement is detected, and off when the room/area is vacated.
- ▶ Additionally, a target light level can be set, meaning luminaires switch off automatically when there is adequate ambient light. Typically this means luminaires are off during brighter periods of the day.
- ▶ Supplied with 5m Sensor Lead, and 10m Switch Drop Lead.
- ▶ Note: Remote Control (FRC/SET) required to set target light level.

DESCRIPTION

PIR Absence/occupancy sensor kit + daylight dependency

PART NO.

FNS1400/U

PRICE

£149.98

PIR Sensor Kits for Dimming Applications

Series 3000 PIR Sensor Kits - use for dimming control.

PIR Detection Pattern

The PIR (Passive Infrared) Sensor detects moving bodies of heat that are different (warmer or cooler) to the background temperature. The detection pattern is broadly rectangular at 9m x 7m when fixed at a ceiling height of 2.5m (longest length of detection aligns with the spring fixing clips).

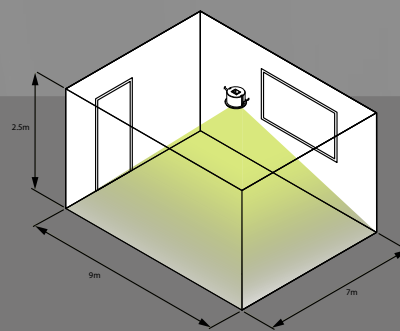

PIR Occupancy Sensor + Daylight Linking

- ▶ Luminaires automatically switch on when movement is detected, and off when the room/area is vacated.
- ▶ Additionally, a target light level can be set, meaning suitable luminaires dim/brighten automatically in response to ambient light conditions, so maintaining an overall constant light level in the area.
- ▶ Supplied with 5m Sensor Lead.
- ▶ Note: Remote Control (FRC/SET) required to set target light level.
- ▶ Note: Analogue and DSI Control Modules are available on request.

DESCRIPTION

PIR occupancy + daylight linking sensor kit, DALI

PART NO. PRICE

FNS3400X **£167.97**



PIR Absence/Occupancy Sensor + Daylight Linking + Manual Dimming

- ▶ You can configure this sensor as either absence or occupancy:
- ▶ In Absence mode, luminaires need to be switched on manually on entry. They will switch off automatically if the room/area is vacated.
- ▶ In Occupancy mode, luminaires switch on automatically when movement is detected, and off when the room/area is vacated.
- ▶ Additionally, a target light level can be set, meaning suitable luminaires dim/brighten automatically in response to ambient light conditions, so maintaining an overall constant light level in the area.
- ▶ Manual Dimming of suitable luminaires can be carried out using a momentary switch. Refer to technical section for information on compatible switches.
- ▶ Supplied with 5m Sensor Lead, and 10m Switch Drop Lead.
- ▶ Note: Remote Control (FRC/SET) required to set target light level.
- ▶ Note: Analogue and DSI Control Modules are available on request.

DESCRIPTION

PIR absence/occupancy + daylight linking + manual dimming sensor kit, DALI

PART NO. PRICE

FNS3400X/U **£180.21**

Microwave Sensor Kits for Non-Dimming Applications

Series 1000 Microwave Sensor Kits - use for standard on/off control.

The Microwave Sensor emits low powered signals which are reflected back off walls and other objects. A change of condition eg. someone entering the room changes the reflected signal, and the sensor detects this as presence. flex7 Microwave Sensors are available as a wall-mounted, or ceiling-mounted option.

Wall-mounted Microwave detection pattern

The detection pattern is broadly rectangular at 25m x 6m when fixed at a height of 2.2m.

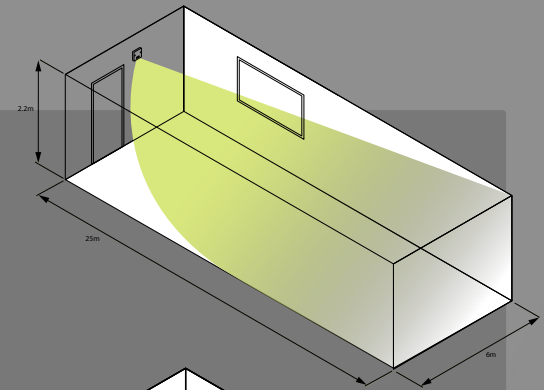

Ceiling-mounted Microwave detection pattern

The detection pattern is elliptical at 8m x 11m when fixed at a ceiling height of 2.5m.

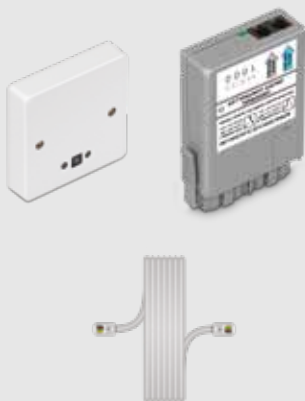
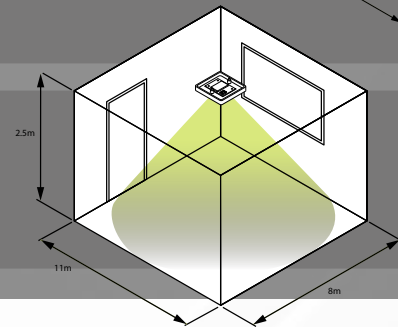

Microwave Occupancy Sensor + Daylight Dependency

- ▶ Luminaires automatically switch on when movement is detected, and off when the room/area is vacated.
- ▶ Additionally, a target light level can be set, meaning luminaires switch off automatically when there is adequate ambient light. Typically this means luminaires are off during brighter periods of the day.
- ▶ Supplied with 5m Sensor Lead.
- ▶ Note: Remote Control (FRC/SET) required to set target light level.

DESCRIPTION	PART NO.	PRICE
Microwave occupancy sensor kit + daylight dependency, ceiling-mounted	FMS1400	£150.61
Microwave occupancy sensor kit + daylight dependency, wall-mounted	FMS/W1400	£150.61



Microwave Absence/Occupancy Sensor + Daylight Dependency

- ▶ You can configure this sensor as either absence or occupancy:
- ▶ In Absence mode, luminaires need to be switched on manually on entry. They will switch off automatically if the room/area is vacated.
- ▶ In Occupancy mode, luminaires switch on automatically when movement is detected, and off when the room/area is vacated.
- ▶ Additionally, a target light level can be set, meaning luminaires switch off automatically when there is adequate ambient light. Typically this means luminaires are off during brighter periods of the day.
- ▶ Supplied with 5m Sensor Lead, and 10m Switch Drop Lead.
- ▶ Note: Remote Control (FRC/SET) required to set target light level.

DESCRIPTION	PART NO.	PRICE
Microwave absence/occupancy sensor kit + daylight dependency, ceiling-mounted	FMS1400/U	£163.71
Microwave absence/occupancy sensor kit + daylight dependency, wall-mounted	FMS/W1400/U	£163.71

Microwave Sensor Kits for Dimming Applications

Series 3000 Microwave sensor kits - use for dimming control.

The Microwave Sensor emits low powered signals which are reflected back off walls and other objects. A change of condition eg. someone entering the room changes the reflected signal, and the sensor detects this as presence.

flex7 Microwave Sensors are available as a wall-mounted, or ceiling-mounted option.



Microwave Occupancy Sensor + Daylight Linking

- ▶ Luminaires automatically switch on when movement is detected, and off when the room/area is vacated.
- ▶ Additionally, a target light level can be set, meaning suitable luminaires dim/brighten automatically in response to ambient light conditions, so maintaining an overall constant light level in the area.
- ▶ Supplied with 5m Sensor Lead.
- ▶ Note: Remote Control (FRC/SET) required to set target light level.
- ▶ Note: Analogue and DSI Control Modules are available on request.

DESCRIPTION

Microwave occupancy + daylight linking, ceiling-mounted, DALI

PART NO.

FMS3400X

PRICE

£175.27

Microwave occupancy + daylight linking, wall-mounted, DALI

FMS/W3400X

£175.27



Microwave Absence/Occupancy Sensor + Daylight Linking + Manual Dimming

- ▶ You can configure this sensor as either absence or occupancy:
- ▶ In Absence mode, luminaires need to be switched on manually on entry. They will switch off automatically if the room/area is vacated.
- ▶ In Occupancy mode, luminaires switch on automatically when movement is detected, and off when the room/area is vacated.
- ▶ Additionally, a target light level can be set, meaning suitable luminaires dim/brighten automatically in response to ambient light conditions, so maintaining an overall constant light level in the area.
- ▶ Manual dimming of suitable luminaires can be carried out using a momentary switch. Refer to technical section for information on compatible switches.
- ▶ Supplied with 5m Sensor Lead, and 10m Switch Drop Lead.
- ▶ Note: Remote Control (FRC/SET) required to set target light level.
- ▶ Note: Analogue and DSI Control Modules are available on request.

DESCRIPTION

Microwave absence/occupancy + daylight linking + manual dimming, ceiling-mounted, DALI

PART NO.

FMS3400X/U

PRICE

£188.35

Microwave absence/occupancy + daylight linking + manual dimming, wall-mounted, DALI

FMS/W3400X/U

£188.35

Hotel Room Energy-Saving Kit







A simple lighting & HVAC control system that delivers the energy savings traditional hotel room key cards don't.

- The kit uses occupancy sensing in conjunction with the room door opening/closing to turn power on when someone enters their hotel room, and automatically turn it off when the occupant leaves.
- Protected Extra Low Voltage (PELV) making it a safe option to use in spaces accessed by the general public.
- Sensor Heads are small and unobtrusive ensuring they blend seamlessly with the room's décor, and the flashing LED is only active during commissioning.
- The control kits are designed to operate in a single bedroom with adjoining ensuite, but can easily be expanded to operate in a multi-room suite of almost any size.
- Suitable for use in new build and retrofit applications.
- More convenient for the guest than inserting/removing a keycard.
- The system can't be fooled, unlike leaving a spare keycard in the holder.

Hotel Room Energy-Saving Kits

DESCRIPTION	PART NO.	PRICE
Energy saving hotel room control pack (1 bedroom and ensuite) to switch contactors with a 230V coil	FNS2200/HOTEL	£287.04
Energy saving hotel room control pack (1 bedroom and ensuite) to switch contactors with 230V coil + separate volt free contact for HVAC control	FNS2200/HOTEL/VF	£320.61

KIT CONTENTS

	1 x Grey 7-pole Socket (FTS07/G)
	1 x Hotel Control Module (FNC2000/HOTEL) OR 1 x Hotel Control Module with additional VF Contact (FNC2000/HOTEL/VF)
	1 x Hotel PIR Sensor Head (FNHPIR/HOTEL) 1 x Hotel PIR Auxiliary Sensor Head (FNH/PIR/AUX/HOTEL)
	2 x Sensor Lead, 5m (FSL05)
	1 x Standard 'Y' Adaptor (FSY/A)
	1 x Switch Drop Lead, 5m (FSW05)

Optional Extras

DESCRIPTION	PART NO.	PRICE
PIR extender pack for larger bedrooms and additional coverage (includes Sensor Head, 10m lead, and 'Y' Adaptor).	FNH/AUX/10/HOTEL	£81.25

Networking Sensors

We have a range of Control Modules that can be networked together in order to share signals over rooms and areas; circuits and phases. This means that luminaires can all be held on in linked areas, turned off with a single switch, emergency test can be initiated on multiple circuits of luminaires simultaneously etc.

A few examples:

Global Emergency Test

If your Control Modules have integrated emergency test then 1 key switch can initiate the test on multiple Control Modules, even if they're controlling luminaires on different circuits, or even different phases.

Global Occupancy

Useful for large areas controlled by many individual Control Modules, on different circuits. Occupancy anywhere in the networked area will operate all lights.

Corridor Hold

Use with a flex7 Corridor Hold Box to operate and hold corridor luminaires on if any adjacent areas are occupied.

Last Man Out Switch

All lights in a building or area can be turned off with a single switch, as you leave the building.

A 'Y' Adaptor is needed to connect the leads to the Control Modules. Contact flex7 for further advice.

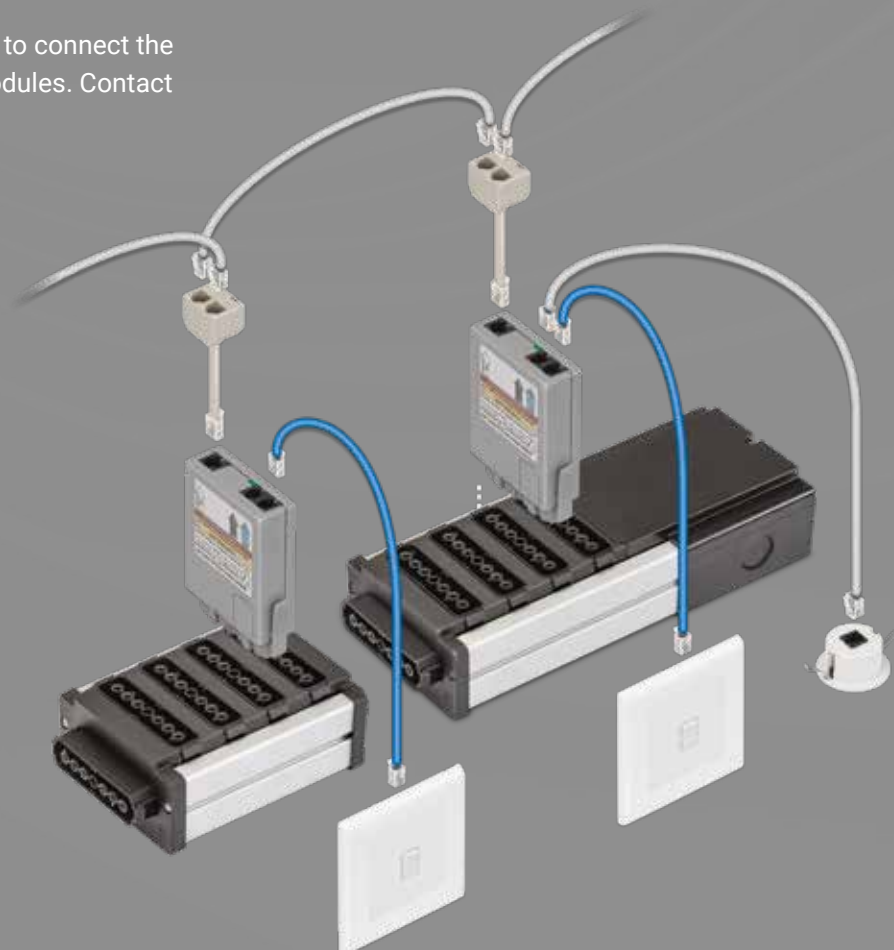

Networkable Control Modules for Non-Dimming Applications

Series 2000 Control Modules - use for standard (on/off) control.



Occupancy Control Module

- ▶ When used with a Sensor Head, PIR or Microwave, luminaires automatically switch on when movement is detected, and off when the room/area is vacated.
- ▶ Additionally, when used with a Sensor Head a target light level can be set, meaning luminaires switch off automatically when there is adequate ambient light. Typically this means luminaires are off during brighter periods of the day.
- ▶ Requires a Sensor Head and Sensor Lead to operate.

DESCRIPTION	PART NO.	PRICE
Networkable occupancy control module	FNC2000	£91.74



Absence Control Module

- ▶ Use with 2-way centre return retractive switch
- ▶ When used with a Sensor Head, PIR or Microwave, luminaires need to be switched on manually on entry. They will automatically switch off when the room/area is vacated.
- ▶ Additionally, when used with a Sensor Head a target light level can be set, meaning luminaires switch off automatically when there is adequate ambient light. Typically this means luminaires are off during brighter periods of the day.
- ▶ Requires a Sensor Head, Sensor Lead and Switch Drop Lead to operate.

DESCRIPTION	PART NO.	PRICE
Networkable absence control module for 2-way centre off retractive switch	FNC2000/AB	£91.74

Networkable Control Modules for Non-Dimming Applications + Integral Emergency Test

Series 2000 Control Modules - use for standard (on/off) control with integral emergency test.



Occupancy + Integral Emergency Test Control Module

- ▶ When used with a Sensor Head, PIR or Microwave, luminaires automatically switch on when movement is detected, and off when the room/area is vacated.
- ▶ Additionally, when used with a Sensor Head a target light level can be set, meaning luminaires switch off automatically when there is adequate ambient light. Typically this means luminaires are off during brighter periods of the day.
- ▶ Complete with additional relay to facilitate routine emergency luminaire test.
- ▶ Requires a Sensor Head and Sensor Lead to operate.
- ▶ Emergency test switch must be latching not retractive.

DESCRIPTION

Networkable occupancy + integral emergency test control module

PART NO.

FNC2000/E

PRICE

£109.61



Absence + Integral Emergency Test Control Module

- ▶ Use with 2-way centre return retractive switch (Relay 1) and 1-way latching key switch (Emergency Test Relay).
- ▶ When used with a Sensor Head, PIR or Microwave, luminaires need to be switched on manually on entry. They will automatically switch off when the room/area is vacated.
- ▶ Additionally, when used with a Sensor Head incorporating a light level sensor a target light level can be set, meaning suitable luminaires switch off automatically when there is adequate ambient light. Typically this means luminaires are off during brighter periods of the day.
- ▶ Complete with additional relay to facilitate routine emergency luminaire test.
- ▶ Requires a Sensor Head, Sensor Lead and Switch Drop Lead to operate.
- ▶ Emergency test switch must be latching not retractive.

DESCRIPTION

Networkable absence + integral emergency test control module for 2-way centre off retractive switch

PART NO.

FNC2000/AB/E

PRICE

£109.61

Networkable Control Modules for Non-Dimming Applications + Second Switch Relay

Series 2000 Control Modules - use for standard (on/off) control with extra switch circuit.

Note: Must be used in conjunction with F2U Distribution Box (see page 16).



Occupancy + Second Switch Relay Control Module

- ▶ When used with a Sensor Head, PIR or Microwave, luminaires automatically switch on when movement is detected, and off when the room/area is vacated.
- ▶ Additionally, when used with a Sensor Head a target light level can be set, meaning luminaires controlled by Relay 1 switch off automatically when there is adequate ambient light, but those controlled by Relay 2 are unaffected. Typically this means luminaires adjacent to windows (Relay 1) are off during brighter periods of the day, whilst those further away (Relay 2) remain on.
- ▶ Requires a Sensor Head and Sensor Lead to operate.

DESCRIPTION	PART NO.	PRICE
Networkable occupancy + second switch relay control module	FNC2000/2	£120.82



Absence + Second Switch Relay Control Module

- ▶ Use with 2-way centre return retractive switch (Relay 1) and 1-way retractive switch (Relay 2).
- ▶ When used with a Sensor Head, PIR or Microwave, luminaires need to be switched on manually on entry. They will automatically switch off when the room/area is vacated.
- ▶ Additionally, when used with a Sensor Head a target light level can be set, meaning luminaires controlled by Relay 1 switch off automatically when there is adequate ambient light, but those controlled by Relay 2 are unaffected. Typically this means luminaires adjacent to windows (Relay 1) are off during brighter periods of the day, whilst those further away (Relay 2) remain on.
- ▶ Requires a Sensor Head, Sensor Lead and Switch Drop Lead to operate.

DESCRIPTION	PART NO.	PRICE
Networkable absence + second switch relay control module for 2-way centre off retractive switch and 1-way retractive switch	FNC2000/AB/2	£120.82



Absence + Second Switch Relay Control Module

- ▶ Use with 2-way centre return retractive switch (Relay 1) and 1-way retractive switch (Relay 2).
- ▶ When used with a Sensor Head, PIR or Microwave, luminaires need to be switched on manually on entry. They will automatically switch off when the room/area is vacated.
- ▶ Additionally, when used with a Sensor Head a target light level can be set, meaning luminaires controlled by Relay 1 switch off automatically when there is adequate ambient light, but those controlled by Relay 2 are unaffected. Typically this means luminaires adjacent to windows (Relay 1) are off during brighter periods of the day, whilst those further away (Relay 2) remain on.
- ▶ Requires a Sensor Head, Sensor Lead and Switch Drop Lead to operate.

DESCRIPTION	PART NO.	PRICE
Absence + second switch relay control module for 2 x 1-way retractive switches	FNC2000/AB/2/L	£122.48

Networkable Control Modules for Dimming Applications

Series 4000 Control Modules - use for dimming control.



Occupancy Control Dimming Module

- ▶ When used with a Sensor Head, PIR or Microwave luminaires automatically switch on when movement is detected, and off when the room/area is vacated.
- ▶ Additionally, when used with a Sensor Head a target light level can be set, meaning suitable luminaires dim/brighten automatically in response to ambient light conditions, so maintaining an overall constant light level in the area.
- ▶ Requires a Sensor Head and Sensor Lead to operate.
- ▶ Note: Analogue and DSI Control Modules are available on request.

DESCRIPTION	PART NO.	PRICE
Networkable occupancy + dimming, DALI	FNC4000X	£107.84



Absence Control Dimming Module

- ▶ Use with 2-way centre return retractive switch.
- ▶ When used with a Sensor Head, PIR or Microwave, luminaires need to be switched on manually on entry. They will automatically switch off when the room/area is vacated.
- ▶ Additionally, when used with a Sensor Head a target light level can be set, meaning suitable luminaires dim/brighten automatically in response to ambient light conditions, so maintaining an overall constant light level in the area.
- ▶ Requires a Sensor Head, Sensor Lead and Switch Drop Lead to operate.
- ▶ The retractive switch can also be used to manually dim/brighten the luminaires.
- ▶ Note: Analogue and DSI Control Modules are available on request.

DESCRIPTION	PART NO.	PRICE
Networkable absence + dimming, DALI, for 2-way centre off retractive switch	FNC4000X/AB	£107.84

Networkable Control Modules for Dimming Applications + Integral Emergency Test

Series 4000 Control Modules - use for dimming control with integral emergency test.



Occupancy Control Dimming Module + Integral Emergency Test

- ▶ When used with a Sensor Head, PIR or Microwave, luminaires automatically switch on when movement is detected, and off when the room/area is vacated.
- ▶ Additionally, when used with a Sensor Head a target light level can be set, meaning suitable luminaires dim/brighten automatically in response to ambient light conditions, so maintaining an overall constant light level in the area.
- ▶ Complete with additional relay to facilitate routine emergency luminaire test.
- ▶ Requires a Sensor Head and Sensor Lead to operate.
- ▶ Emergency test switch must be latching, not retractive.
- ▶ Note: Analogue and DSI Control Modules are available on request.

DESCRIPTION	PART NO.	PRICE
Networkable occupancy + dimming + integral emergency test, DALI	FNC4000X/E	£130.54



Absence Control Dimming Module + Integral Emergency Test

- ▶ Use with 2-way centre return retractive switch (Relay 1) and 1-way latching key switch (Emergency Test Relay).
- ▶ When used with a Sensor Head, PIR or Microwave, luminaires need to be switched on manually on entry. They will automatically switch off when the room/area is vacated.
- ▶ Additionally, when used with a Sensor Head a target light level can be set, meaning suitable luminaires dim/brighten automatically in response to ambient light conditions, so maintaining an overall constant light level in the area.
- ▶ Complete with additional relay to facilitate routine emergency luminaire test.
- ▶ Requires a Sensor Head, Sensor Lead and Switch Drop Lead to operate.
- ▶ Emergency test switch must be latching, not retractive.
- ▶ Note: Analogue and DSI Control Modules are available on request.

DESCRIPTION	PART NO.	PRICE
Networkable absence + dimming + integral test, DALI, for 2-way centre off retractive switch	FNC4000X/AB/E	£130.54

Networkable Control Modules for Dimming Applications + Second Switch Relay

Series 4000 Control Modules - use for dimming control with extra switch circuit.

Note: must be used in conjunction with F2U Distribution Box (see page 16)



Occupancy Control Dimming Module + Second Switch Relay

- ▶ When used with a Sensor Head, PIR or Microwave, luminaires automatically switch on when movement is detected, and off when the room/area is vacated.
- ▶ Additionally, when used with a Sensor Head a target light level can be set, meaning suitable luminaires dim/brighten automatically in response to ambient light conditions, so maintaining an overall constant light level in the area.
- ▶ Requires a Sensor Head and Sensor Lead to operate.
- ▶ Note: Analogue and DSI Control Modules are available on request.

DESCRIPTION

Networkable occupancy + dimming + 2nd switch relay DALI

PART NO. PRICE

FNC4000X/2 **£145.54**



Absence Control Dimming Module + Second Switch Relay

- ▶ Use with 2-way centre return retractive switch (Relay 1) and 1-way retractive switch (Relay 2).
- ▶ When used with a Sensor Head, PIR or Microwave, luminaires need to be switched on manually on entry. They will automatically switch off when the room/area is vacated.
- ▶ Additionally, when used with a Sensor Head a target light level can be set, meaning suitable luminaires dim/brighten automatically in response to ambient light conditions, so maintaining an overall constant light level in the area.
- ▶ Relays 1 & 2 can be manually switched independently of one another via the retractive switches.
- ▶ Requires a Sensor Head, Sensor Lead and Switch Drop Lead to operate.
- ▶ Note: Analogue and DSI Control Modules are available on request.

DESCRIPTION

Networkable absence + dimming + 2nd switch relay, DALI, for 2-way centre off retractive switch

PART NO. PRICE

FNC4000X/AB/2 **£145.54**



Absence Control Dimming Module + Second Switch Relay

- ▶ Use with 2-way centre return retractive switch (Relay 1) and 1-way retractive switch (Relay 2).
- ▶ When used with a Sensor Head, PIR or Microwave, luminaires need to be switched on manually on entry. They will automatically switch off when the room/area is vacated.
- ▶ Additionally, when used with a Sensor Head a target light level can be set, meaning suitable luminaires dim/brighten automatically in response to ambient light conditions, so maintaining an overall constant light level in the area.
- ▶ Relays 1 & 2 can be manually switched independently of one another via the retractive switches.
- ▶ Requires a Sensor Head, Sensor Lead and Switch Drop Lead to operate.
- ▶ Note: Analogue and DSI Control Modules are available on request.

DESCRIPTION	PART NO.	PRICE
Networkable absence + dimming + 2nd switch relay, DALI, for 3-position centre return switch	FNC4000X/AB/2/L	£147.84



Networking Leads

- ▶ Use to connect suitable Control Modules together to create a network.
- ▶ Leads are available in a number of different lengths.

DESCRIPTION	PART NO.	PRICE
Networking lead, LSHF, 5 metre	FNL05	£13.05
Networking lead, LSHF, 10 metre	FNL10	£22.58
Networking lead, LSHF, 20 metre	FNL20	£42.03
Networking lead, LSHF, 30 metre	FNL30	£64.37

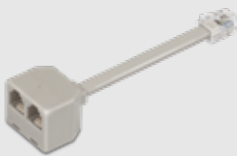

Networking Adaptor

- ▶ Use to connect networking leads to Control Modules.

DESCRIPTION	PART NO.	PRICE
Networking Adaptor	FNY/A	£7.61

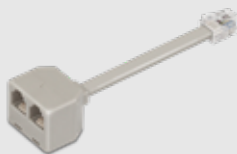

Corridor Hold Interface

- ▶ Use to keep luminaires in specific parts of a building on whilst other areas are occupied eg. a corridor/circulation area is lit whenever an adjacent room is in use.
- ▶ The interface does not require a mains supply, and is connected to a Control Module via a plug-in Network Lead.
- ▶ Each Corridor Hold Interface accepts up to 8 x inputs with 2 x outputs. It is however, possible to link 2 or more together, increasing the number of possible inputs in multiples of 8.



DESCRIPTION	PART NO.	PRICE
Corridor Hold Interface - 2 inputs / 1 output	FCH2/1	£59.32
Corridor Hold Interface - 8 inputs / 2 outputs	FCH8/2	£162.59



Timer Management Interface

- ▶ Use to keep luminaires on in specific parts of a building, at predetermined times of the day eg. all core areas are lit during normal working hours, and reverting to occupancy control at all other times.
- ▶ The interface is a single channel/7-day device and is connected to a Control Module via a plug-in Network Lead.
- ▶ Timed control of luminaires in multiple areas requires a Zone Splitter (below).

DESCRIPTION	PART NO.	PRICE
Timer Management Interface	FTM100	£624.07

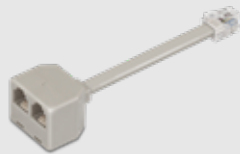

Zone Splitter

- ▶ Use to connect luminaires in up to 8 separate areas to a Timer Management Interface eg. all zones are lit by Timer Management Interface during programmed hours, but revert to being separately controlled at all other times.
- ▶ The Splitter does not require a mains supply and is connected to a Control Module and the Timer Management Interface via plug-in Network Leads.
- ▶ Each Splitter accepts up to 1 x inputs with 8 x outputs, but it is possible to link 2 or more together, increasing the number of possible outputs in multiples of 8.

DESCRIPTION	PART NO.	PRICE
2-Zone Splitter - 2 outputs / 1 input	FTM2Z	£59.32
8-Zone Splitter - 8 outputs / 2 inputs	FTM8Z	£162.59

3rd Party Control Leads

Use with 3rd party (non-flex7) control modules.

Connect free end of lead to appropriate terminals of device.

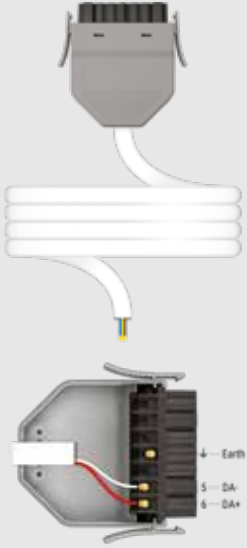

2-Core DALI Control Lead, Grey With White Cable

- ▶ Use with DALI devices (powered by DALI bus).

DESCRIPTION	LSHF CABLE	PRICE
1.50mm cable, 2 metre	FW2150LSHF2/GC	£14.54
1.50mm cable, 3 metre	FW2150LSHF3/GC	£17.29
1.50mm cable, 5 metre	FW2150LSHF5/GC	£23.21
1.50mm cable, 7 metre	FW2150LSHF7/GC	£29.10



4-Core Control Lead, Grey With White Cable

- ▶ Use with 3rd party, 230V on/off control devices.

DESCRIPTION	LSHF CABLE	PRICE
1.50mm cable, 2 metre	FW4150LSHF2/GC	£19.11
1.50mm cable, 3 metre	FW4150LSHF3/GC	£23.32
1.50mm cable, 5 metre	FW4150LSHF5/GC	£31.51
1.50mm cable, 7 metre	FW4150LSHF7/GC	£40.13



5-Core Control Lead, Grey With White Cable

- ▶ Use with dimmable 3rd party 230V control devices (DSI or DALI - no relay).

DESCRIPTION

1.50mm cable, 2 metre	FW5150LSHF2/GC	£21.61
1.50mm cable, 3 metre	FW5150LSHF3/GC	£26.62
1.50mm cable, 5 metre	FW5150LSHF5/GC	£36.46
1.50mm cable, 7 metre	FW5150LSHF7/GC	£45.91

LSHF CABLE

PRICE

FW5150LSHF2/GC	£21.61
FW5150LSHF3/GC	£26.62
FW5150LSHF5/GC	£36.46
FW5150LSHF7/GC	£45.91



6-Core Control Lead, Grey With White Cable

- ▶ Use with dimmable, 3rd party 230V control devices (Analogue, DSI or DALI - with relay).

DESCRIPTION

1.50mm cable, 2 metre	FW6150LSHF2/GC	£25.61
1.50mm cable, 3 metre	FW6150LSHF3/GC	£31.70
1.50mm cable, 5 metre	FW6150LSHF5/GC	£44.44
1.50mm cable, 7 metre	FW6150LSHF7/GC	£55.95

LSHF CABLE

PRICE

FW6150LSHF2/GC	£25.61
FW6150LSHF3/GC	£31.70
FW6150LSHF5/GC	£44.44
FW6150LSHF7/GC	£55.95

flex7 Switches

Our unique range of plug-in Switches connect to the Control Module using a factory prepared Switch Drop Lead incorporating RJ connectors. One end of the lead plugs straight into the Control Module, the other simply plugs directly into the switch – no on-site terminations are necessary. Alternatively, the Switch Drop Lead can be hardwired into the terminals of a 3rd party switch if preferred.

flex7 lighting controls operate at Protected Extra Low Voltage (PELV) so regardless of how deep you sink it into the wall you won't necessarily need to enclose the Switch Drop Lead in an earthed metallic enclosure / covering or provide RCD circuit protection.

Retractive (momentary) Switch

A switch where the rocker springs back to a default position when released, allowing 'pulsed' operation.

Latched Switch (not available from flex7 - 3rd party only)

A switch where the rocker stays in the position it is moved to when released.

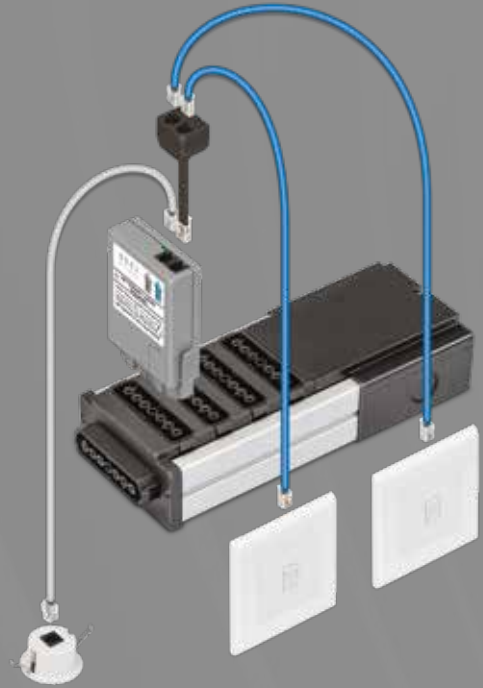

Simple plug-in connection via RJ ready lead

Unlike traditional hard-wired switches, flex7 Switches incorporate RJ connectivity meaning termination takes a second and requires no screwdrivers, strippers or earthing/sleeving. Installation time is reduced to a minimum as a result, especially when all the additional benefits of using a PELV system are taken into account.



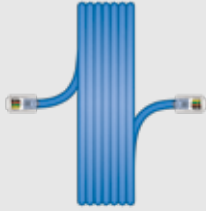

Switch Drop Leads for flex7 Switches

- ▶ Use to connect a Control Module to a flex7 switch.
- ▶ flex7 controls operate at Protected Extra Low Voltage (PELV) this mean Switch Drop Leads can be installed at any depth within the wall, and will not require mechanical and RCD Protection, whilst remaining fully compliant with current IET wiring regulations.

DESCRIPTION	PART NO.	PRICE
Switch drop lead, LSHF, 5 metre	FSL05/BL	£9.70
Switch drop lead, LSHF, 10 metre	FSL10/BL	£15.96
Switch drop lead, LSHF, 20 metre	FSL20/BL	£27.14
Switch drop lead, LSHF, 30 metre	FSL30/BL	£41.16



Switch Drop Leads for 3rd Party Switches

- ▶ Use to connect a Control Module to a 3rd party switch with screwed terminals.
- ▶ flex7 controls operate at Protected Extra Low Voltage (PELV) this mean Switch Drop Leads can be installed at any depth within the wall, and will not require mechanical and RCD Protection, whilst remaining fully compliant with current IET wiring regulations.

DESCRIPTION	PART NO.	PRICE
3rd party switch drop lead, LSHF, 5 metre	FSW05	£10.97
3rd party switch drop lead, LSHF, 10 metre	FSW10	£17.71
3rd party switch drop lead, LSHF, 20 metre	FSW20	£29.89
3rd party switch drop lead, LSHF, 30 metre	FSW30	£42.68



'Y' Adaptor

- ▶ Use to plug 2 leads into a single Control Module. For use with Link Leads or Switch Drop Leads.

DESCRIPTION	PART NO.	PRICE
'Y' Adaptor	FSY/A	£6.69

Switch Kits for Non-Dimming Applications

Series 1000 Switches - Use for manual on/off control.



Manual Switching Kit

- ▶ Luminaires must be switched on/off manually.
- ▶ Use with a flex7 plug-in switch or 3rd party switch.
- ▶ Supplied with a 10m Switch Drop Lead.
- ▶ Switch not included.

DESCRIPTION	PART NO.	PRICE
Manual switch kit	FNS1000/U	£75.64

Switch Kits for Dimming Applications

Series 3000 Switches - Use for manual dimming control.



Manual Dimming & Switching Kits

- ▶ Luminaires must be switched on/off and dimmed/brightened manually.
- ▶ Use with a flex7 plug-in switch or 3rd party switch.
- ▶ Supplied with a 10m Switch Drop Lead.
- ▶ Switch not included.
- ▶ Note: Analogue and DSI Control Modules are available on request.

DESCRIPTION	PART NO.	PRICE
Manual dimming switch kit, DALI	FNS3000X/U	£107.64

Switches

flex7 Switches uniquely incorporate RJ connectivity, meaning no on-site termination is required; the Switch Drop Lead simply plugs-in.

Switches can be supplied with a decorative fascia, or will fit into any manufacturer's single gang 50mm x 50mm Euro Module faceplate.

Switches must be used in conjunction with a Control Module. A Switch Drop Lead is needed to connect the Switch to a Control Module.



White Switch Modules

- ▶ Use if you wish to source your own decorative fascia.
- ▶ Clips into 50mm x 50mm Euromod style fascia.

DESCRIPTION	2-WAY CENTRE RETURN RETRACTIVE SWITCH	PRICE	1-WAY RETRACTIVE SWITCH	PRICE
1-Gang switch module, white	FWS01/M/AB/W	£26.22	FWS01/M/AT/W	£26.22
2-Gang switch module, white	FWS02/M/AB/W	£28.13	FWS02/M/AT/W	£28.13
3-Gang switch module, white	FWS03/M/AB/W	£35.60	FWS03/M/AT/W	£35.60
4-Gang switch module, white	FWS04/M/AB/W	£42.75	FWS04/M/AT/W	£42.75



Black Switch Modules

- ▶ Use if you wish to source your own decorative fascia.
- ▶ Clips into 50mm x 50mm Euromod style fascia.

DESCRIPTION	2-WAY CENTRE RETURN RETRACTIVE SWITCH	PRICE	1-WAY RETRACTIVE SWITCH	PRICE
1-Gang switch module, black	FWS01/M/AB/B	£26.22	FWS01/M/AT/B	£26.22
2-Gang switch module, black	FWS02/M/AB/B	£28.13	FWS02/M/AT/B	£28.13
3-Gang switch module, black	FWS03/M/AB/B	£35.60	FWS03/M/AT/B	£35.60
4-Gang switch module, black	FWS04/M/AB/B	£42.75	FWS04/M/AT/B	£42.75

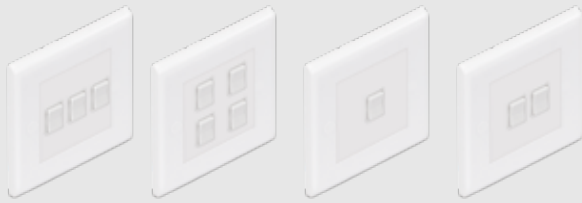

White Switch Modules + Decorative Fascia

► Switch module complete with white decorative fascia.

DESCRIPTION	2-WAY CENTRE RETURN RETRACTIVE SWITCH	PRICE	1-WAY RETRACTIVE SWITCH	PRICE
1-Gang switch module + fascia, white	FWS01/K/AB/W/WP	£32.36	FWS01/K/AT/W/WP	£32.36
2-Gang switch module + fascia, white	FWS02/K/AB/W/WP	£34.27	FWS02/K/AT/W/WP	£34.27
3-Gang switch module + fascia, white	FWS03/K/AB/W/WP	£41.74	FWS03/K/AT/W/WP	£41.74
4-Gang switch module + fascia, white	FWS04/K/AB/W/WP	£48.89	FWS04/K/AT/W/WP	£48.89



Black Switch Modules + Decorative Fascia

► Switch module complete with satin steel decorative fascia.

DESCRIPTION	2-WAY CENTRE RETURN RETRACTIVE SWITCH	PRICE	1-WAY RETRACTIVE SWITCH	PRICE
1-Gang switch module + fascia, black/silver	FWS01/K/AB/B/SS	£55.04	FWS01/K/AT/B/SS	£55.04
2-Gang switch module + fascia, black/silver	FWS02/K/AB/B/SS	£56.95	FWS02/K/AT/B/SS	£56.95
3-Gang switch module + fascia, black/silver	FWS03/K/AB/B/SS	£64.42	FWS03/K/AT/B/SS	£64.42
4-Gang switch module + fascia, black/silver	FWS04/K/AB/B/SS	£71.57	FWS04/K/AT/B/SS	£71.57



'Y' Adaptor

► Required to configure certain Switch Modules to a flex7 Control Module. The type you require will depend on the combination of Switch/Control Module used.

DESCRIPTION	PART NO.	PRICE
Switch adaptor, for 1-way retractive switch + FNS1000 or FNS3000 Kits	FWSY13/AT	£18.64
Switch adaptor, for 2-way centre return retractive switch + FNS3000 Kits	FWSY3/AB	£18.64

ZoneLite Lighting Control Module

ZoneLite combines all the features of a flex7 Lighting Distribution Box with the power of 4 integrated and fully networked Control Modules, making it possible to connect and control 4 groups of luminaires from a central point.

ZoneLite Lighting Control Modules are available in two variants; Type T and Type G. Type T variants are predominantly aimed at education environments whereas Type G variants lend themselves more to commercial installations; offices; retail etc. Both types are so flexible however that either can be ideally suited to a whole host of installations and applications.

Each variant is pre-configured with 15 on-site selectable lighting scenarios, so there's one to suit most installation requirements, whether the luminaires are split across 4 individual rows or over 4 individual rooms.

ZoneLite's on-board control software allows the following options to be easily applied on a group by group basis by the installer, negating the need for specialist and expensive commissioning

ZoneLite utilises the flex7 philosophy of plug-in Sensor Heads, Switches and Scene Set Plates, dramatically reducing the number of on-site terminations required, making for quick, cost effective installation and maintenance as a result.

- Occupancy
- Absence
- Manual switching and / or dimming
- Daylight linking
- Off-set daylight linking
- Scene setting and recall
- Light level set back
- Emergency luminaire test
- 'Last Man Out' function
- 'All On' function

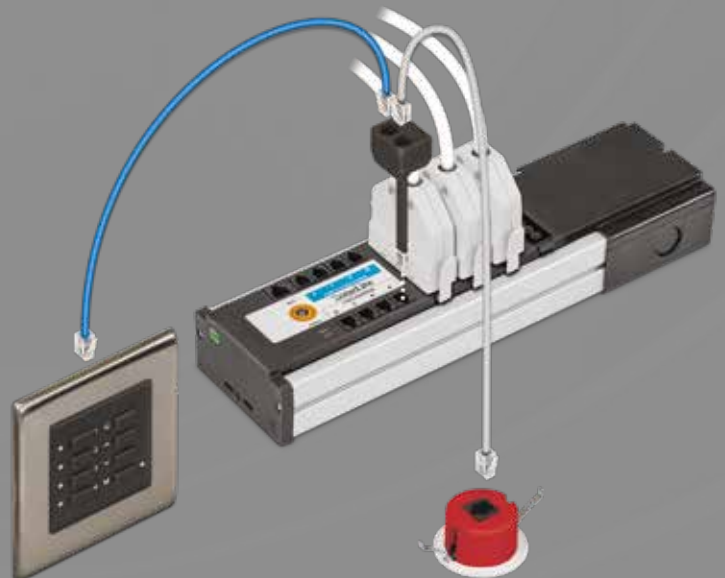

ZoneLite can also accept up to 3 global switch commands:

Emergency Test - Test all emergency fitting.

Last Man Out - Turn all connected luminaires off.

All Lights On - Turn all connected luminaires on.



ZoneLite Control Module - Type T

- ▶ Use for teaching spaces, teaching spaces with adjoining cloakrooms, and meeting rooms.

DESCRIPTION	PART NO.	PRICE
ZoneLite 4-way, 4 channel, Type T	FZL04T1111	£591.60



ZoneLite Control Module - Type G

- ▶ Use for single, multiple, or open plan offices, meeting rooms and retail environments.

DESCRIPTION	PART NO.	PRICE
ZoneLite 4-way, 4 channel, Type G	FZL04G1111	£591.60

ZoneLite PIR Sensor Heads

ZoneLite PIR Sensor Heads need to be used in conjunction with a ZoneLite Control Module. A Sensor Lead is needed to connect the Sensor Head to a ZoneLite Control Module.

PIR Detection Pattern

The PIR (Passive Infrared) Sensor detects moving bodies of heat that are different (warmer or cooler) to the background temperature. The detection pattern is broadly rectangular at 9m x 7m when fixed at a ceiling height of 2.5m (longest length of detection aligns with the fixing clips).

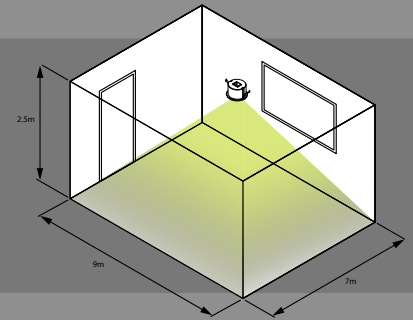

ZoneLite PIR Absence/Occupancy & Light Level Sensor Head

- ▶ Use for occupancy or absence with daylight dependency/linking. If a light level is set, the Sensor Head will monitor ambient light and turn on/off or dim/brighten luminaires as required. If no target level is set lights will remain at full brightness.
- ▶ The integral infrared receiver accepts commands from either the ZoneLite Remote Control (FZL/RC) or User (FRC/USER) Remote Control. An LED provides indication of operation.
- ▶ Requires a ZoneLite Control Module and Sensor Lead to operate.

DESCRIPTION

ZoneLite PIR occupancy & light level sensor head, white
 ZoneLite PIR occupancy & light level sensor head, black

PART NO. PRICE

FZH/PIR/LS £72.80
 FZH/PIR/LS/BK £72.80



ZoneLite PIR Auxiliary Sensor Head

- ▶ Use to increase the area of detection. Up to 5 Auxiliary Heads (per channel) can be used in conjunction with 1 'Primary' Head, effectively increasing detection range 6-fold. Ideal for use in corridors or large/irregular shaped rooms.
- ▶ Can be used with ZoneLite PIR or ZoneLite Microwave Sensors.
- ▶ Supplied with a 'Y' adaptor to allow plug-in connection of 2 Sensor Leads (in/out).
- ▶ Requires a ZoneLite 'Primary' Sensor Head, ZoneLite Control Module, and Sensor Lead to operate.

DESCRIPTION

ZoneLite PIR auxiliary sensor head, white
 ZoneLite PIR auxiliary sensor head, black

PART NO. PRICE

FZH/PIR/AUX £67.82
 FZH/PIR/AUX/BK £67.82

ZoneLite Surface Mount PIR Sensor Heads

Using the 2 x M4 screws supplied, fix directly to a standard BESA box with 50.8mm fixing centres in surface mount installations. Alternatively, replace the M4 screws supplied with security type fixings and use in installations where resilience to unsolicited attempts to remove or tamper is paramount; public areas, prisons, secure units etc.

Surface Mount / Tamper Resistant PIR Absence/Occupancy & Light Level Sensor Head

- ▶ Use for occupancy or absence with daylight dependency/linking. If a target light level is set, the Sensor Head will monitor ambient light and turn on/off or dim/brighten luminaires as required. If no target level is set lights will remain at full brightness.
- ▶ The integral infrared receiver accepts commands from either the ZoneLite Remote Control (FZL/RC) or User (FRC/USER) Remote Control. An LED provides indication of operation.
- ▶ Requires a ZoneLite Control Module and Sensor Lead to operate.

DESCRIPTION	PART NO.	PRICE
ZoneLite Surface mount PIR occupancy & light level sensor head, white	FZH/PIR/LS/S	£120.70
ZoneLite Surface mount PIR occupancy & light level sensor head, black	FZH/PIR/LS/S/BK	£120.70

Surface Mount / Tamper Resistant Auxiliary PIR Sensor Head

- ▶ Use to increase the area of detection. Up to 5 Auxiliary Heads can be used in conjunction with 1 'Primary' Head, effectively increasing detection range by 6-fold. Ideal for use in corridors or large/irregular shaped rooms.
- ▶ Can be used with PIR or Microwave Sensors (excl. 230V version).
- ▶ Supplied with a 'Y' adaptor to allow plug-in connection of 2 Sensor Leads (in/out).
- ▶ Requires a 'Primary' Sensor Head, Control Module and Sensor Lead to operate.

DESCRIPTION	PART NO.	PRICE
ZoneLite Surface mount auxiliary PIR sensor head, white	FZH/PIR/AUX/S	£109.81
ZoneLite Surface mount auxiliary PIR sensor head, black	FZH/PIR/AUX/S/BK	£109.81



ZoneLite IP67 PIR Sensor Heads

For use in external installations where protection from moisture is needed.



IP67 PIR Absence/Occupancy & Light Level Sensor Head

- ▶ Use for occupancy or absence with daylight dependency/linking. If a target light level is set, the Sensor Head will monitor ambient light and turn on/off or dim/brighten luminaires as required. If no target level is set lights will remain at full brightness.
- ▶ The integral infrared receiver accepts commands from either the ZoneLite Remote Control (FZL/RC) or User (FRC/USER) Remote Control. An LED provides indication of operation.
- ▶ Supplied complete with factory connected 5 metre Sensor Lead.
- ▶ Requires a ZoneLite Control Module to operate.

DESCRIPTION

PART NO.

PRICE

ZoneLite IP67 occupancy + light level sensing head, white

FZH/PIR/LS/IP67

£142.02

ZoneLite IP67 occupancy + light level sensing head, black

FZH/PIR/LS/IP67/BK

£142.02



IP67 Auxiliary PIR Sensor Head

- ▶ Use to increase the area of detection. Up to 5 Auxiliary Heads can be used in conjunction with 1 'Primary' Head, effectively increasing detection range by 6-fold. Ideal for use in corridors or large/irregular shaped rooms.
- ▶ Can be used with PIR or Microwave Sensors (excl. 230V version).
- ▶ Supplied with a 'Y' adaptor to allow plug-in connection of 2 Sensor Leads (in/out).
- ▶ Supplied complete with factory connected 5 metre Sensor Lead.

DESCRIPTION

PART NO.

PRICE

ZoneLite IP67 auxiliary sensor head, white

FZH/PIR/AUX/IP67

£125.63

ZoneLite IP67 auxiliary sensor head, black

FZH/PIR/AUX/IP67/BK

£125.63

*ZoneLite Control Modules are IP2X and must be sited in a suitable location.

ZoneLite Microwave Sensor Heads

ZoneLite Microwave Sensor Heads need to be used in conjunction with a ZoneLite Control Module. A Sensor Lead is required to connect the Sensor Head to a ZoneLite Control Module.

The ZoneLite Microwave sensor emits low powered signals which are reflected back off walls and other objects. A change of condition eg. someone entering the room changes the reflected signal, and the sensor detects this as presence. flex7 ZoneLite Microwave Sensors are available as a wall-mounted, or ceiling-mounted option.

Wall-mounted Microwave detection pattern

The detection pattern is broadly rectangular at 25m x 6m when fixed at a height of 2.2m.

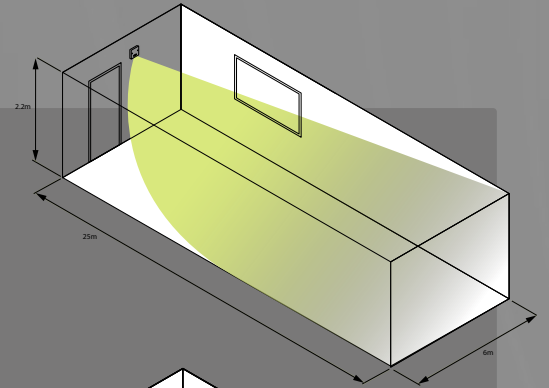

Ceiling-mounted Microwave detection pattern

The detection pattern is elliptical at 8m x 11m when fixed at a ceiling height of 2.5m.

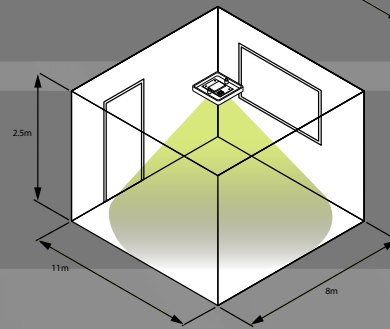

ZoneLite Microwave Absence/Occupancy & Light Level Sensor Head

- ▶ Use (in conjunction with a ZoneLite Control Module) for occupancy or absence with daylight dependency/linking. Once a target level has been set, the Sensor Head will monitor ambient light and turn on/off or dim/brighten luminaires as required. If no target level is set lights will remain at full brightness.
- ▶ The integral infrared receiver accepts commands from either the ZoneLite (FZL/RC) or User (FRC/USER) Remote Control. An LED provides indication of operation.
- ▶ Requires a ZoneLite Control Module and Sensor Lead to operate.

DESCRIPTION	PART NO.	PRICE
ZoneLite microwave occupancy + light level, ceiling-mounted	FZH/M	£92.13
ZoneLite microwave occupancy + light level, wall-mounted	FZH/M/W	£92.13



ZoneLite Setup Remote Control

- ▶ Use to change timeout settings, light levels and other operational modes during commissioning.
- ▶ The ZoneLite Setup Remote Control can adjust the following parameters (depending on configuration):
 - ▶ Dimming control (manual/daylight linking and daylight dependency).
 - ▶ Detection type (occupancy/absence)
 - ▶ Sensitivity settings
 - ▶ Timeout setting
 - ▶ Dimming load type (DSI or DALI)
 - ▶ Offset dimming illumination levels
 - ▶ Configuration setting
 - ▶ Set back illumination levels.
- ▶ Note: Factory default for Sensor timeout is 20 mins.

DESCRIPTION	PART NO.	PRICE
ZoneLite Setup Remote Control	FZL/RC	£71.45

Scene Setting Plates

Programme up to 4 scenes, and instantly recall them with the press of a button. Scenes can be further adjusted while in use if needed, by dimming up/down individual channels.

Scene Setting Plates can be supplied with a decorative fascia, or will fit into any manufacturer's single gang 50mm x 50mm Euro Module faceplate.

Multiple Scene Setting Plates can be daisy chained to a single ZoneLite controller. They can also be used with flex7 PIR Sensor Heads if absence or occupancy control is required. In line with the rest of the flex7 lighting connection and control range, the Scene Setting Plate utilises simple plug-in connection, using a standard RJ12 connection.



- Recalls up to 4 independent light scenes.
- Switch on/off and brighten/dim up to 4 separate groups of luminaires.
- Fast and simple plug-in installation.
- Available in black or white to suit your decor.
- Clips into any manufacturer's 50mm x 50mm Euro Module faceplate.

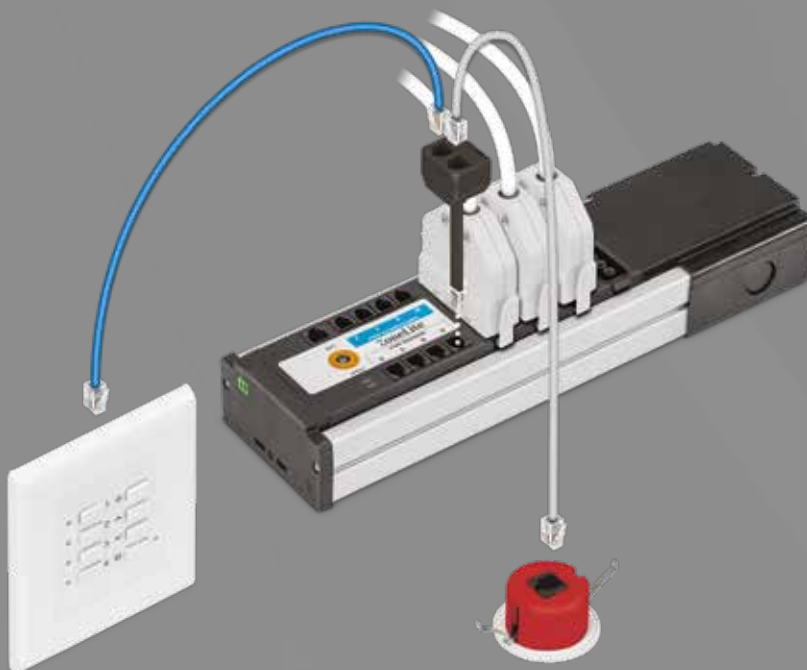

White Scene Set Plate Modules



- ▶ Use if you wish to source your own decorative fascia.
- ▶ Clips into any 50mm x 50mm Euromod style decorative fascia.
- ▶ Must be used in conjunction with a ZoneLite Control Module.
- ▶ A Switch Drop Lead is needed to connect the Scene Set Plate to a ZoneLite Control Module.

DESCRIPTION

Scene set plate module only, white

PART NO. PRICE

FSS04/M/W **£256.48**

Black Scene Set Plate Modules



- ▶ Use if you wish to source your own decorative fascia.
- ▶ Clips into any 50mm x 50mm Euromod style decorative fascia.
- ▶ Must be used in conjunction with a ZoneLite Control Module.
- ▶ A Switch Drop Lead is needed to connect the Scene Set Plate to a ZoneLite Control Module.

DESCRIPTION

Scene set plate module only, black

PART NO. PRICE

FSS04/M/B **£256.48**

White Scene Set Plate Modules + Decorative Fascia



- ▶ Scene Set Plate module complete with white decorative fascia.
- ▶ Must be used in conjunction with a ZoneLite Control Module.
- ▶ A Switch Drop Lead is needed to connect the Scene Set Plate to a ZoneLite Control Module.

DESCRIPTION

Scene set plate, white module, with white decorative fascia

PART NO. PRICE

FSS04/K/W/WP **£259.51**

Black Scene Set Plate Modules + Decorative Fascia



- ▶ Scene Set Plate module complete with satin steel decorative fascia.
- ▶ Must be used in conjunction with a ZoneLite Control Module.
- ▶ A Switch Drop Lead is needed to connect the Scene Set Plate to a ZoneLite Control Module.

DESCRIPTION

Scene set plate, black module, with satin steel decorative fascia

PART NO. PRICE

FSS04/K/B/SS **£275.31**

Conference Room Scene Setting Kit

Designed as a simple plug-together solution for conference rooms, this kit offers plug and play lighting connection and control that allows the user to set and recall 4 scenes.







There is no need for expensive commissioning; the wall mounted scene setting plate can easily be programmed by the end user.

- Full plug and play connection for rapid, simple installation.
- 4 scenes can be set and recalled by the user.
- Integrated emergency light test facility.
- Occupancy or absence control to automatically switch lights off when the meeting room is vacant.
- Switch or dim luminaires across 4 channels.
- Switch Drop Leads operate at Protected Extra Low Voltage, which means they do not require any extra protection from an RCD, or enclosing in an earthed metallic covering, as is often the requirement for mains switch drops.



Conference Room Scene Set Kit

- ▶ Use for Scene Setting Applications in conference/meeting rooms or similar.
- ▶ Additional Luminaire and Double Extender Leads will be required.

DESCRIPTION	PART NO.	PRICE
Conference room scene set kit	FZS04/K/01	£998.46
KIT CONTENTS		
 1 x ZoneLite 4-way, 4 channel Type G (FZL04G1111)		
 4 x 7-pole Black Plugs (FP7/B)		
 1 x Scene Setting Plate, black with satin steel frame (FSS04/K/B/SS)		
 1 x ZoneLite PIR sensor Head (FZH/PIR/LS)		
 2 x Sensor Lead, 15m (FSL15)		
 1 x 'Y' Adaptor (FSY/A)		
 1 x ZoneLite Setup Remote Control (FZL/RC)		



3-7 Pole Plug-in Ceiling Rose

Prota is the world's first 7-pole 'decorative' plug-in ceiling rose. Incorporating the trusted flex7 plug and socket interface, Prota is ideal for surface installations where final connection to the luminaire has to be aesthetically pleasing.

The socket fits onto any standard BESA box. Suitable for standard, dimmable, or specialist lighting applications. The plug latches into place with a satisfying 'click' and the decorative cover, secured with a simple quarter twist, provides the finishing touch.

- Available in black, white, and red options.
- Available in 3-7 pole options (incl. earth).
- Suitable for all lighting applications; simple on/off, dimmable or specialised.
- Large capacity terminals; easily accept 5 x 1.50mm² conductors.
- Suitable for on-load connection/disconnection of luminaires.
- Easy to remove cover.
- 100% tested at point of manufacture.
- Designed and manufactured in the UK.

Easily accessible side-facing terminals:

Side-facing terminals provide easy access for test equipment probes. Simply remove the socket cover to access. There is no need to pull the socket away from the BESA box, so no need to disturb the fixed wiring.



Socket sits completely flush to BESA box:

There is no back projection of the socket into the BESA box, which means wiring space is maximised. This reduces the risk of trapping/stressing conductors as the socket is secured.



Cover & Sockets

Prota plugs are not available unwired, but we do offer an extensive range of Luminaire Leads.



Prota Decorative Cover

- ▶ The Decorative Cover fits neatly over the plug and socket with a simple quarter-twist action. This ensures the cover remains securely in place, but is easy to remove when required.

DESCRIPTION	PART NO.	PRICE
Decorative Cover, white (Box of 10)	PDC/W	£2.00 EA.
Decorative Cover, red (Box of 10)	PDC/R	£2.00 EA.
Decorative Cover, black (Box of 10)	PDC/B	£2.00 EA.



Prota Sockets

- ▶ Prota sockets are supplied with captivated M4 fixing screws. They mount directly to any standard BESA box. The socket sits completely flush against the conduit box, with no back projection into it. This maximises wiring space.
- ▶ Side accessible terminals make testing and fault finding post installation easy and trouble-free. Terminals easily accept 5 x 1.50mm² conductors.

DESCRIPTION	PART NO.	PRICE
3-Pole Socket, white (Box of 10)	PS03/W	£6.74 EA.
4-Pole Socket, white (Box of 10)	PS04/W	£7.74 EA.
5-Pole Socket, white (Box of 10)	PS05/W	£9.64 EA.
6-Pole Socket, white (Box of 10)	PS06/W	£11.20 EA.
7-Pole Socket, white (Box of 10)	PS07/W	£12.94 EA.
3-Pole Socket, black (Box of 10)	PS03/B	£6.74 EA.
4-Pole Socket, black (Box of 10)	PS04/B	£7.74 EA.
5-Pole Socket, black (Box of 10)	PS05/B	£9.64 EA.
6-Pole Socket, black (Box of 10)	PS06/B	£11.20 EA.
7-Pole Socket, black (Box of 10)	PS07/B	£12.94 EA.

Prota Luminaire Leads

We offer an extensive range of Luminaire Leads which minimise installation time. All variants are available in Low Smoke Halogen Free (LSHF) cable, in accordance with BS EN 50525-3-11 and CPR rated to category Cca, so you can be assured that they'll meet required safety standards for public and commercial buildings. White cable is available in all variants, and black cable is available in 1.00mm² LSHF.

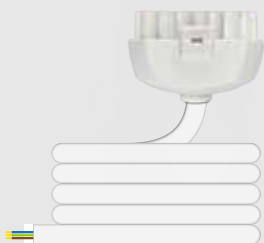

Prota Standard Luminaire Leads, All White

- ▶ 3-core luminaire lead for use with standard (on/off) luminaires.
- ▶ All luminaire leads in range are 100% tested, and come with ferruled conductors at free end.
- ▶ Socket Compatibility:

PS03/W ✓	PS04/W ✓	PS05/W ✓	PS06/W ✓	PS07/W ✓
----------	----------	----------	----------	----------

DESCRIPTION	LSHF CABLE	PRICE
0.75mm white cable, 2 metre	PL375LSHF2/W	£11.03
0.75mm white cable, 3 metre	PL375LSHF3/W	£12.69
0.75mm white cable, 5 metre	PL375LSHF5/W	£16.71
0.75mm white cable, 7 metre	PL375LSHF7/W	£20.30
1.00mm white cable, 2 metre	PL3100LSHF2/W	£11.77
1.00mm white cable, 3 metre	PL3100LSHF3/W	£13.82
1.00mm white cable, 5 metre	PL3100LSHF5/W	£18.35
1.00mm white cable, 7 metre	PL3100LSHF7/W	£22.55
1.50mm white cable, 2 metre	PL3150LSHF2/W	£13.26
1.50mm white cable, 3 metre	PL3150LSHF3/W	£15.98
1.50mm white cable, 5 metre	PL3150LSHF5/W	£21.84
1.50mm white cable, 7 metre	PL3150LSHF7/W	£27.36

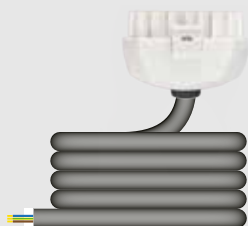

Prota Standard Luminaire Leads, White With Black Cable

- ▶ 3-core luminaire lead for use with standard (on/off) luminaires.
- ▶ All luminaire leads in range are 100% tested, and come with ferruled conductors at free end.
- ▶ Socket Compatibility:

PS03/B ✓	PS04/B ✓	PS05/B ✓	PS06/B ✓	PS07/B ✓
----------	----------	----------	----------	----------

DESCRIPTION	LSHF CABLE	PRICE
1.00mm black cable, 2 metre	PL3100LSHF2/WB	£13.30
1.00mm black cable, 3 metre	PL3100LSHF3/WB	£15.78
1.00mm black cable, 5 metre	PL3100LSHF5/WB	£21.01
1.00mm black cable, 7 metre	PL3100LSHF7/WB	£26.02

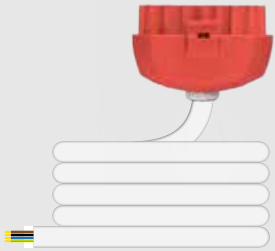

Protalight Emergency Luminaire Leads, Red With White Cable

- ▶ Use with maintained emergency luminaires.
- ▶ 4-core luminaire lead for use with maintained emergency luminaires.
- ▶ All luminaire leads in range are 100% tested, and come with ferruled conductors at free end.
- ▶ Socket Compatibility:

PS03/W ✘	PS04/W ✔	PS05/W ✘	PS06/W ✔	PS07/W ✔
----------	----------	----------	----------	----------

DESCRIPTION	LSHF CABLE	PRICE
0.75mm white cable, 2 metre	PL475LSHF2/R	£13.07
0.75mm white cable, 3 metre	PL475LSHF3/R	£15.36
0.75mm white cable, 5 metre	PL475LSHF5/R	£20.22
0.75mm white cable, 7 metre	PL475LSHF7/R	£24.84
1.00mm white cable, 2 metre	PL4100LSHF2/R	£14.31
1.00mm white cable, 3 metre	PL4100LSHF3/R	£17.18
1.00mm white cable, 5 metre	PL4100LSHF5/R	£23.18
1.00mm white cable, 7 metre	PL4100LSHF7/R	£28.95
1.50mm white cable, 2 metre	PL4150LSHF2/R	£16.83
1.50mm white cable, 3 metre	PL4150LSHF3/R	£20.62
1.50mm white cable, 5 metre	PL4150LSHF5/R	£28.50
1.50mm white cable, 7 metre	PL4150LSHF7/R	£36.12

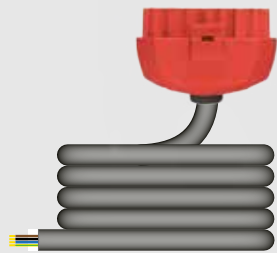

Protalight Emergency Luminaire Leads, Red With Black Cable

- ▶ Use with maintained emergency luminaires.
- ▶ 4-core luminaire lead for use with maintained emergency luminaires.
- ▶ All luminaire leads in range are 100% tested, and come with ferruled conductors at free end.
- ▶ Socket Compatibility:

PS03/B ✘	PS04/B ✔	PS05/B ✘	PS06/B ✔	PS07/B ✔
----------	----------	----------	----------	----------

DESCRIPTION	LSHF CABLE	PRICE
1.00mm black cable, 2 metre	PL4100LSHF2/RB	£16.41
1.00mm black cable, 3 metre	PL4100LSHF3/RB	£19.95
1.00mm black cable, 5 metre	PL4100LSHF5/RB	£27.32
1.00mm black cable, 7 metre	PL4100LSHF7/RB	£34.44



Prota Dimmable Luminaire Leads, All White

- ▶ 5-core luminaire lead for use with dimmable luminaires.
- ▶ All luminaire leads in range are 100% tested, and come with ferruled conductors at free end.
- ▶ Socket Compatibility:

PS03/W ✘	PS04/W ✘	PS05/W ✔	PS06/W ✔	PS07/W ✔
----------	----------	----------	----------	----------

DESCRIPTION	LSHF CABLE	PRICE
0.75mm white cable, 2 metre	PL575LSHF2/W	£16.23
0.75mm white cable, 3 metre	PL575LSHF3/W	£19.22
0.75mm white cable, 5 metre	PL575LSHF5/W	£25.49
0.75mm white cable, 7 metre	PL575LSHF7/W	£31.49
1.00mm white cable, 2 metre	PL5100LSHF2/W	£17.36
1.00mm white cable, 3 metre	PL5100LSHF3/W	£20.69
1.00mm white cable, 5 metre	PL5100LSHF5/W	£27.83
1.00mm white cable, 7 metre	PL5100LSHF7/W	£34.64

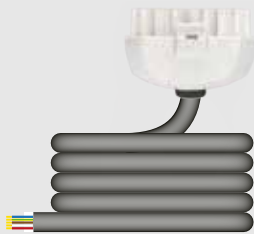

Prota Dimmable Luminaire Leads, White With Black Cable

- ▶ 5-core luminaire lead for use with dimmable luminaires.
- ▶ All luminaire leads in range are 100% tested, and come with ferruled conductors at free end.
- ▶ Socket Compatibility:

PS03/B ✘	PS04/B ✘	PS05/B ✔	PS06/B ✔	PS07/B ✔
----------	----------	----------	----------	----------

DESCRIPTION	LSHF CABLE	PRICE
1.00mm black cable, 2 metre	PL5100LSHF2/WB	£20.51
1.00mm black cable, 3 metre	PL5100LSHF3/WB	£24.98
1.00mm black cable, 5 metre	PL5100LSHF5/WB	£34.31
1.00mm black cable, 7 metre	PL5100LSHF7/WB	£43.34

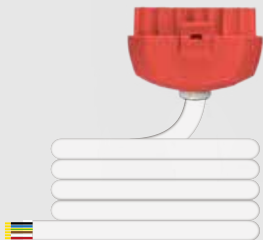

Protalux Dimmable Maintained Emergency Luminaire Leads, Red With White Cable

- ▶ 6-core luminaire lead for use with dimmable, maintained emergency luminaires.
- ▶ All luminaire leads in range are 100% tested, and come with ferruled conductors at free end.
- ▶ Socket Compatibility:

PS03/W	✘	PS04/W	✘	PS05/W	✘	PS06/W	✔	PS07/W	✔
--------	---	--------	---	--------	---	--------	---	--------	---

DESCRIPTION	LSHF CABLE	PRICE
0.75mm white cable, 2 metre	PL675LSHF2/R	£20.21
0.75mm white cable, 3 metre	PL675LSHF3/R	£24.47
0.75mm white cable, 5 metre	PL675LSHF5/R	£33.53
0.75mm white cable, 7 metre	PL675LSHF7/R	£42.21
1.00mm white cable, 2 metre	PL6100LSHF2/R	£21.15
1.00mm white cable, 3 metre	PL6100LSHF3/R	£25.76
1.00mm white cable, 5 metre	PL6100LSHF5/R	£35.42
1.00mm white cable, 7 metre	PL6100LSHF7/R	£44.74

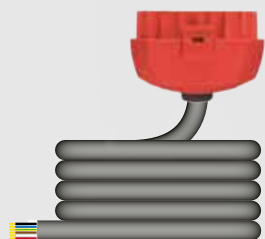

Protalux Dimmable Maintained Emergency Luminaire Leads, Red With Black Cable

- ▶ 6-core luminaire lead for use with dimmable, maintained emergency luminaires.
- ▶ All luminaire leads in range are 100% tested, and come with ferruled conductors at free end.
- ▶ Socket Compatibility:

PS03/B	✘	PS04/B	✘	PS05/B	✘	PS06/B	✔	PS07/B	✔
--------	---	--------	---	--------	---	--------	---	--------	---

DESCRIPTION	LSHF CABLE	PRICE
1.00mm black cable, 2 metre	PL6100LSHF2/RB	£25.73
1.00mm black cable, 3 metre	PL6100LSHF3/RB	£32.05
1.00mm black cable, 5 metre	PL6100LSHF5/RB	£45.19
1.00mm black cable, 7 metre	PL6100LSHF7/RB	£57.95

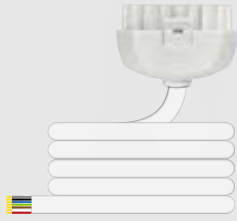

Prota Luminaire Leads For Special Applications, All White

- ▶ 7-core luminaire lead for use with bespoke luminaires eg. luminaires that have multiple switch lives.
- ▶ All luminaire leads in range are 100% tested, and come with ferruled conductors at free end.
- ▶ Socket Compatability: PS03/W ✘ PS04/W ✘ PS05/W ✘ PS06/W ✘ PS07/W ✔

DESCRIPTION	LSHF CABLE	PRICE
0.75mm white cable, 2 metre	PL775LSHF2/W	£21.67
0.75mm white cable, 3 metre	PL775LSHF3/W	£26.06
0.75mm white cable, 5 metre	PL775LSHF5/W	£35.32
0.75mm white cable, 7 metre	PL775LSHF7/W	£44.21
1.00mm white cable, 2 metre	PL7100LSHF2/W	£23.81
1.00mm white cable, 3 metre	PL7100LSHF3/W	£28.88
1.00mm white cable, 5 metre	PL7100LSHF5/W	£39.48
1.00mm white cable, 7 metre	PL7100LSHF7/W	£49.72

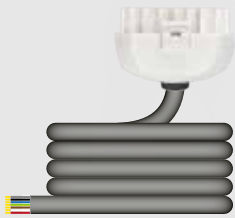

Prota Luminaire Leads For Special Applications, White With Black Cable

- ▶ 7-core luminaire lead for use with bespoke luminaires eg. luminaires that have multiple switch lives.
- ▶ All luminaire leads in range are 100% tested, and come with ferruled conductors at free end.
- ▶ Socket Compatability: PS03/B ✘ PS04/B ✘ PS05/B ✘ PS06/B ✘ PS07/B ✔

DESCRIPTION	LSHF CABLE	PRICE
1.00mm black cable, 2 metre	PL7100LSHF2/WB	£28.40
1.00mm black cable, 3 metre	PL7100LSHF3/WB	£35.08
1.00mm black cable, 5 metre	PL7100LSHF5/WB	£49.04
1.00mm black cable, 7 metre	PL7100LSHF7/WB	£62.54

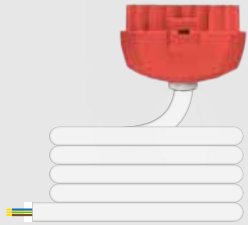

Prota Non-Maintained Emergency Luminaire Leads, Red With White Cable

- ▶ 3-core luminaire lead for use with non-maintained, emergency luminaires.
- ▶ Luminaire leads are 100% tested, and come with ferruled conductors at free end.
- ▶ Socket Compatability:

PS03/W ✘	PS04/W ✔	PS05/W ✘	PS06/W ✔	PS07/W ✔
----------	----------	----------	----------	----------

DESCRIPTION	LSHF CABLE	PRICE
0.75mm white cable, 2 metre	PL375LSHF2/RE	£12.17
0.75mm white cable, 3 metre	PL375LSHF3/RE	£14.06
0.75mm white cable, 5 metre	PL375LSHF5/RE	£18.18
0.75mm white cable, 7 metre	PL375LSHF7/RE	£22.06
1.00mm white cable, 2 metre	PL3100LSHF2/RE	£12.93
1.00mm white cable, 3 metre	PL3100LSHF3/RE	£15.17
1.00mm white cable, 5 metre	PL3100LSHF5/RE	£19.96
1.00mm white cable, 7 metre	PL3100LSHF7/RE	£24.55
1.50mm white cable, 2 metre	PL3150LSHF2/RE	£14.63
1.50mm white cable, 3 metre	PL3150LSHF3/RE	£17.60
1.50mm white cable, 5 metre	PL3150LSHF5/RE	£23.75
1.50mm white cable, 7 metre	PL3150LSHF7/RE	£29.72

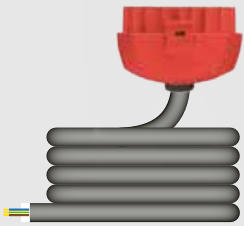

Prota Non-Maintained Emergency Luminaire Leads, Red With Black Cable

- ▶ 3-core luminaire lead for use with non-maintained, emergency luminaires.
- ▶ All luminaire leads in range are 100% tested, and come with ferruled conductors at free end.
- ▶ Socket Compatability:

PS03/B ✘	PS04/B ✔	PS05/B ✘	PS06/B ✔	PS07/B ✔
----------	----------	----------	----------	----------

DESCRIPTION	LSHF CABLE	PRICE
1.00mm black cable, 2 metre	PL3100LSHF2/RBE	£13.78
1.00mm black cable, 3 metre	PL3100LSHF3/RBE	£16.34
1.00mm black cable, 5 metre	PL3100LSHF5/RBE	£21.75
1.00mm black cable, 7 metre	PL3100LSHF7/RBE	£26.95



Prota Permanent Supply Luminaire Leads, All White

- ▶ 3-core luminaire lead for use where each luminaire has an integral PIR, and no external control device is required.
- ▶ All luminaire leads in range are 100% tested, and come with ferruled conductors at free end.
- ▶ Socket Compatability:

PS03/W ✘	PS04/W ✘	PS05/W ✘	PS06/W ✘	PS07/W ✔
----------	----------	----------	----------	----------

DESCRIPTION	LSHF CABLE	PRICE
0.75mm white cable, 2 metre	PL375LSHF2/WP	£14.20
0.75mm white cable, 3 metre	PL375LSHF3/WP	£16.14
0.75mm white cable, 5 metre	PL375LSHF5/WP	£20.30
0.75mm white cable, 7 metre	PL375LSHF7/WP	£24.23
1.00mm white cable, 2 metre	PL3100LSHF2/WP	£14.96
1.00mm white cable, 3 metre	PL3100LSHF3/WP	£17.24
1.00mm white cable, 5 metre	PL3100LSHF5/WP	£22.10
1.00mm white cable, 7 metre	PL3100LSHF7/WP	£26.75
1.50mm white cable, 2 metre	PL3150LSHF2/WP	£16.68
1.50mm white cable, 3 metre	PL3150LSHF3/WP	£19.68
1.50mm white cable, 5 metre	PL3150LSHF5/WP	£25.95
1.50mm white cable, 7 metre	PL3150LSHF7/WP	£32.00

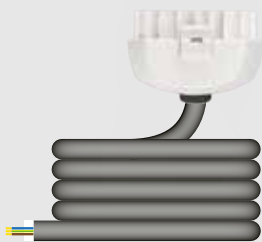

Prota Permanent Supply Luminaire Leads, White With Black Cable

- ▶ 3-core luminaire lead for use where each luminaire has an integral PIR, and no external control device is required.
- ▶ All luminaire leads in range are 100% tested, and come with ferruled conductors at free end.
- ▶ Socket Compatability:

PS03/B ✘	PS04/B ✘	PS05/B ✘	PS06/B ✘	PS07/B ✔
----------	----------	----------	----------	----------

DESCRIPTION	LSHF CABLE	PRICE
1.00mm black cable, 2 metre	PL3100LSHF2/WBP	£15.87
1.00mm black cable, 3 metre	PL3100LSHF3/WBP	£18.46
1.00mm black cable, 5 metre	PL3100LSHF5/WBP	£23.93
1.00mm black cable, 7 metre	PL3100LSHF7/WBP	£29.19

Prota DALI and DALI Maintained Emergency Luminaire Leads

Use with luminaires that are controlled solely by a DALI signal (or similar protocol) and as such do not require mains rated switched live.

Luminaire leads ending "D" derive their permanent supply separately to the emergency supply (non-emergency luminaires remain operational during an emergency test).



Prota DALI Luminaire Leads, All White

- ▶ Live on Pin 1.
- ▶ 5-core luminaire lead for use with luminaire controlled by DALI (or similar) protocol.
- ▶ All luminaire leads in range are 100% tested, and come with ferruled conductors at free end.
- ▶ This luminaire lead has no facility for a switched live.
- ▶ Non-emergency luminaires remain operational during emergency test.
- ▶ Socket Compatibility:

PS03/W	✗	PS04/W	✗	PS05/W	✗	PS06/W	✗	PS07/W	✓
--------	---	--------	---	--------	---	--------	---	--------	---

DESCRIPTION	LSHF CABLE	PRICE
0.75mm white cable, 2 metre	PL575LSHF2/WD	£17.53
0.75mm white cable, 3 metre	PL575LSHF3/WD	£20.74
0.75mm white cable, 5 metre	PL575LSHF5/WD	£27.48
0.75mm white cable, 7 metre	PL575LSHF7/WD	£33.97
1.00mm white cable, 2 metre	PL5100LSHF2/WD	£18.73
1.00mm white cable, 3 metre	PL5100LSHF3/WD	£22.36
1.00mm white cable, 5 metre	PL5100LSHF5/WD	£30.06
1.00mm white cable, 7 metre	PL5100LSHF7/WD	£37.36

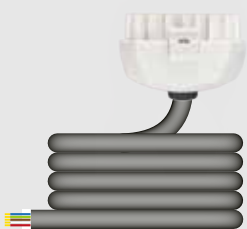

Prota DALI Luminaire Leads, White With Black Cable

- ▶ Live on Pin 1.
- ▶ 5-core luminaire lead for use with luminaire controlled by DALI (or similar) protocol.
- ▶ All luminaire leads in range are 100% tested, and come with ferruled conductors at free end.
- ▶ This luminaire lead has no facility for a switched live.
- ▶ Non-emergency luminaires remain operational during emergency test.
- ▶ Socket Compatibility:

PS03/B	✗	PS04/B	✗	PS05/B	✗	PS06/B	✗	PS07/B	✓
--------	---	--------	---	--------	---	--------	---	--------	---

DESCRIPTION	LSHF CABLE	PRICE
1.00mm black cable, 2 metre	PL5100LSHF2/WBD	£21.09
1.00mm black cable, 3 metre	PL5100LSHF3/WBD	£25.68
1.00mm black cable, 5 metre	PL5100LSHF5/WBD	£35.28
1.00mm black cable, 7 metre	PL5100LSHF7/WBD	£44.56

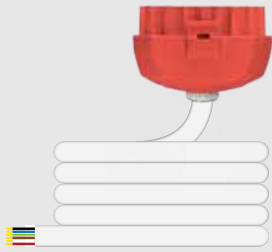

Protalux DALI + Maintained Emergency Luminaire Leads, Red With White Cable

- ▶ Live on Pin 1.
- ▶ 6-core luminaire lead for use with maintained emergency luminaire controlled by DALI (or similar) protocol.
- ▶ All luminaire leads in range are 100% tested, and come with ferruled conductors at free end.
- ▶ This luminaire lead has no facility for a switched live.
- ▶ Non-emergency luminaires remain operational during emergency test.
- ▶ Socket Compatibility:

PS03/W	✘	PS04/W	✘	PS05/W	✘	PS06/W	✘	PS07/W	✓
--------	---	--------	---	--------	---	--------	---	--------	---

DESCRIPTION	LSHF CABLE	PRICE
0.75mm white cable, 2 metre	PL675LSHF2/RD	£21.83
0.75mm white cable, 3 metre	PL675LSHF3/RD	£26.47
0.75mm white cable, 5 metre	PL675LSHF5/RD	£36.21
0.75mm white cable, 7 metre	PL675LSHF7/RD	£45.60
1.00mm white cable, 2 metre	PL6100LSHF2/RD	£22.84
1.00mm white cable, 3 metre	PL6100LSHF3/RD	£27.82
1.00mm white cable, 5 metre	PL6100LSHF5/RD	£38.25
1.00mm white cable, 7 metre	PL6100LSHF7/RD	£48.33

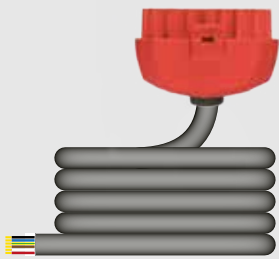

Protalux DALI + Maintained Emergency Luminaire Leads, Red With Black Cable

- ▶ Live on Pin 1.
- ▶ 6-core luminaire lead for use with maintained emergency luminaire controlled by DALI (or similar) protocol.
- ▶ All luminaire leads in range are 100% tested, and come with ferruled conductors at free end.
- ▶ This luminaire lead has no facility for a switched live.
- ▶ Non-emergency luminaires remain operational during emergency test.
- ▶ Socket Compatibility:

PS03/B	✘	PS04/B	✘	PS05/B	✘	PS06/B	✘	PS07/B	✓
--------	---	--------	---	--------	---	--------	---	--------	---

DESCRIPTION	LSHF CABLE	PRICE
1.00mm black cable, 2 metre	PL6100LSHF2/RBD	£26.45
1.00mm black cable, 3 metre	PL6100LSHF3/RBD	£32.95
1.00mm black cable, 5 metre	PL6100LSHF5/RBD	£46.46
1.00mm black cable, 7 metre	PL6100LSHF7/RBD	£59.58

Technical Information

PLUG PIN DESIGNATION FOR PROTA LUMINAIRE LEADS

PIN	3 POLE	4 POLE	5 POLE	6 POLE	7 POLE
1					Perm/L
2		Em/L		Em/L	Em/L
3	N	N	N	N	N
E	⊕	⊕	⊕	⊕	⊕
4	Sw/L	Sw/L	Sw/L	Sw/L	Sw/L
5			DA-	DA-	DA-
6			DA+	DA+	DA+

PIN	/E Variant	/P Variant	/D Variant	/X Variant
1		Perm/L	Perm/L	Em/L
2	Em/L	Em/L	Em/L	N
3	N	N	N	⊕
E	⊕	⊕	⊕	⊕
4			DA-	DA-
5			DA+	DA+
6				

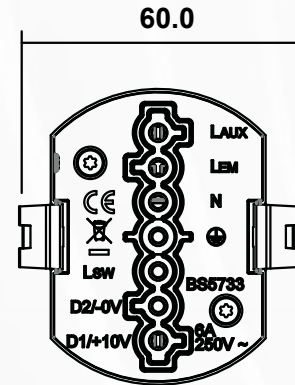

TERMINAL CONFIGURATION FOR PROTA SOCKET

3 POLE WITH LOOP	4 POLE WITH LOOP	5 POLE	6 POLE	7 POLE
N LOOP ⊕ Sw/L	Em/L N LOOP ⊕ Sw/L	N ⊕ Sw/L DA- DA+	Em/L N ⊕ Sw/L DA- DA+	Perm/L Em/L N ⊕ Sw/L DA- DA+

PROTA PLUG, SOCKET & DECORATIVE COVER

SUPPLY VOLTAGE:	230V~
CURRENT RATING:	6A
FREQUENCY:	50Hz
TERMINAL CAPACITY (SOCKET):	5 x 1.50mm ² , 3 x 2.50mm ² , 2 x 4.00mm ² , 1 x 6.00mm ²
MATERIAL SPECIFICATION (MOULDED):	PA6, Halogen Free, UL94 V0 PC, Halogen Free, UL94, V0
INGRESS PROTECTION:	IP2X
OPERATING TEMPERATURE:	-5°C / +40°C

PROTA SOCKET DIMENSIONS

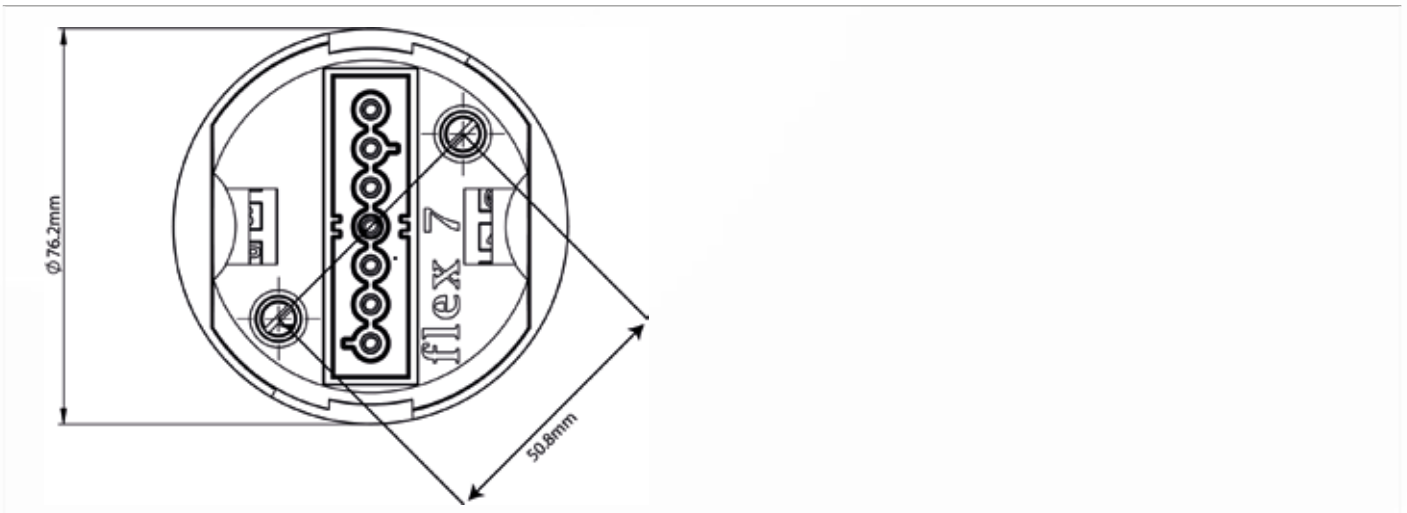

PROTA PLUG DIMENSIONS

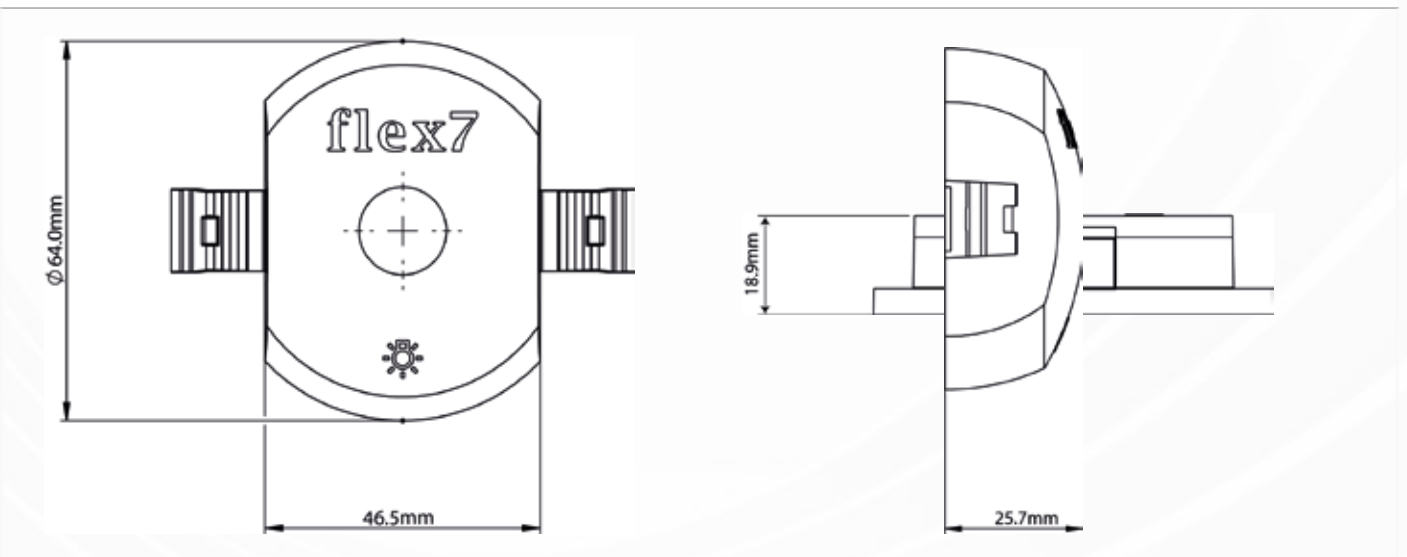

PROTA DECORATIVE COVER DIMENSIONS



FLEX7 SINGLE SOCKET OUTLETS (SURFACE MOUNT - CONDUIT BOX / TRUNKING MOUNT PLATE) DIMENSIONS

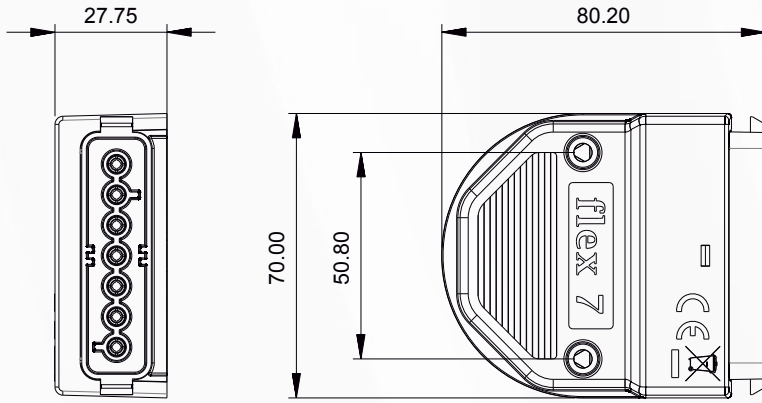

FLEX7 SINGLE SOCKET OUTLET

SUPPLY VOLTAGE:	230V~
CURRENT RATING:	16A
FREQUENCY:	50Hz
TERMINAL CAPACITY:	5 x 1.50mm ² , 3 x 2.50mm ² conductors, 2 x 4.00mm ² or 1x6.0mm ²
MATERIAL SPECIFICATION (MOULDED):	PA6, Halogen Free, UL94, V0
INGRESS PROTECTION:	IP2X
OPERATING TEMPERATURE RANGE:	-5°C / +40°C

FLEX7 TRUNKING MOUNT PLATE DIMENSIONS

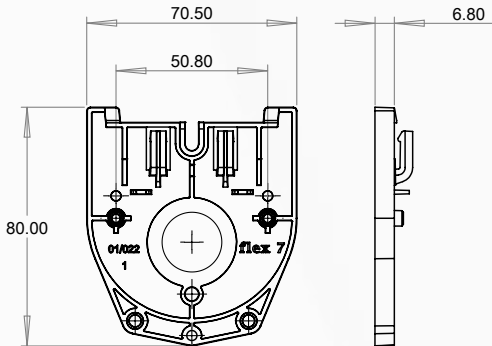

FLEX7 TRUNKING MOUNT PLATE

CABLE ENTRY (KNOCKOUT):	20mm Ø (order /20) 25mm Ø (order /25)
MATERIAL SPECIFICATION (MOULDED):	PA6, Halogen Free, UL94, V0
INGRESS PROTECTION:	IP2X
OPERATING TEMPERATURE RANGE:	-5°C / +40°C

FLEX7 STARTER DISTRIBUTION BOX DIMENSIONS

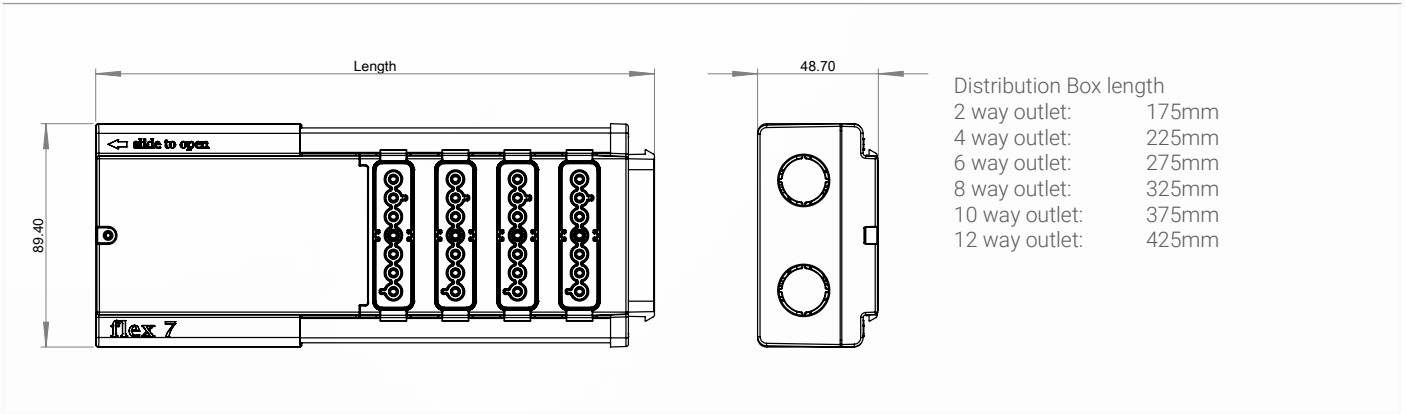

FLEX7 STARTER DISTRIBUTION BOX

SUPPLY VOLTAGE:	230V~
CURRENT RATING:	16A (7 contacts per outlet, each rated at 16A)
FREQUENCY:	50Hz
TERMINAL CAPACITY (SOCKET):	5 x 1.50mm ² , 3 x 2.50mm ² conductors, 2 x 4.00mm ² or 1 x 6.0mm ²
CABLE ENTRY (KNOCKOUT):	4 x 20mm Ø (sides) 1 x 25mm Ø (rear)
MATERIAL SPECIFICATION (MOULDED):	PA6, Halogen Free, UL94, V0 PC/ABS, UL94, V0
INGRESS PROTECTION:	IP2X
OPERATING TEMPERATURE RANGE:	-5°C / +40°C

FLEX7 EXPANSION & TAP-OFF DISTRIBUTION BOX DIMENSIONS

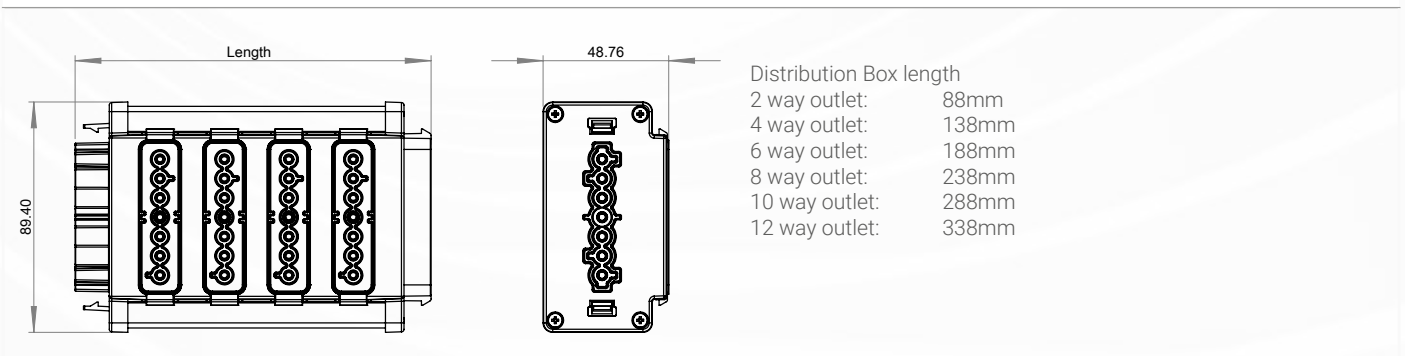

FLEX7 EXPANSION & TAP-OFF DISTRIBUTION BOX

SUPPLY VOLTAGE:	230V~
CURRENT RATING:	16A
FREQUENCY:	50Hz
TERMINAL CAPACITY (SOCKET):	N/A
CABLE ENTRY (KNOCKOUT):	N/A
MATERIAL SPECIFICATION:	PA6, Halogen Free, UL94, V0
INGRESS PROTECTION:	IP2X
OPERATING TEMPERATURE RANGE:	-5°C / +40°C

HUB DIMENSIONS

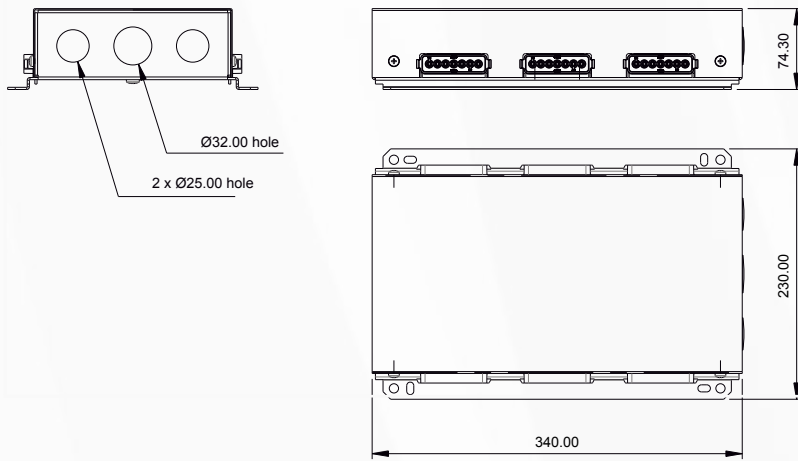

HUBS

SUPPLY VOLTAGE:	400V~
CURRENT RATING:	16A
FREQUENCY:	50Hz
TERMINAL CAPACITY (SOCKET):	3 x 2.50mm ² , 2 x 4.00mm ² , 1 x 6.00mm ²
MATERIAL SPECIFICATION:	1.20mm - 2.00mm thick mild steel
INGRESS PROTECTION:	IP2X
OPERATING TEMPERATURE:	-5°C / +40°C

FLEX7 2-POLE AUXILIARY ADAPTOR UNIT DIMENSIONS

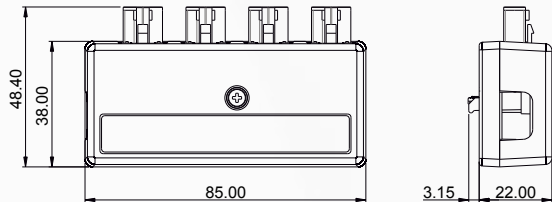

FLEX7 2-POLE AUXILIARY ADAPTOR UNIT

SUPPLY VOLTAGE:	230V~
CURRENT RATING:	6A
MATERIAL SPECIFICATION (MOULDED):	PA6, Halogen Free, UL94, V0
INGRESS PROTECTION:	IP2X
OPERATING TEMPERATURE RANGE:	-5°C / +40°C

FLEX7 2-POLE AUXILIARY ADAPTOR PLUG DIMENSIONS

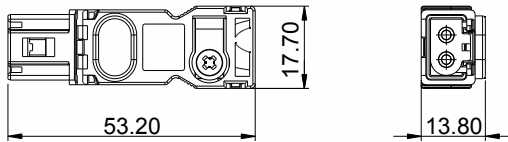

FLEX7 2-POLE AUXILIARY ADAPTOR PLUG

SUPPLY VOLTAGE:	230V~
CURRENT RATING:	10A
MATERIAL SPECIFICATION (MOULDED):	PA6, Halogen Free, UL94, V0
INGRESS PROTECTION:	IP2X
OPERATING TEMPERATURE RANGE:	-5°C / +40°C

FLEX7 PLUG (CABLE MOUNT) DIMENSIONS

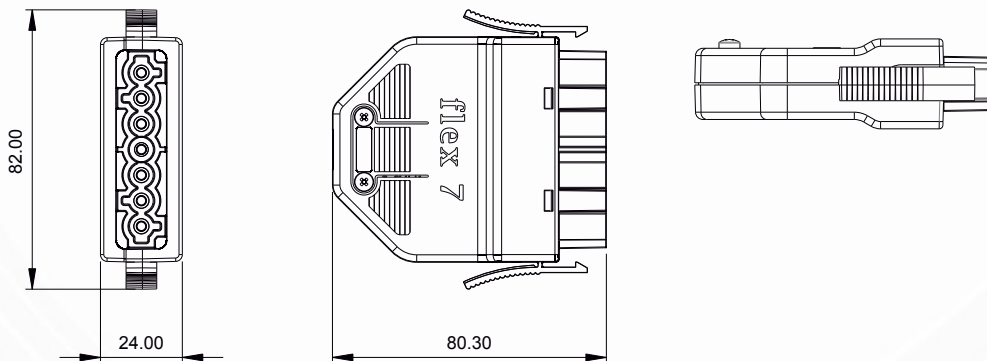

FLEX7 PLUG (CABLE MOUNT)

SUPPLY VOLTAGE:	230V~
CURRENT RATING:	16A
FREQUENCY:	50Hz
TERMINAL CAPACITY:	0.50mm ² to 2.50mm ²
CORD GRIP CAPACITY:	11.50mm ² Ø
MATERIAL SPECIFICATION (MOULDED):	PA6, Halogen Free, UL94, V0
INGRESS PROTECTION:	IP2X
OPERATING TEMPERATURE RANGE:	-5°C / +40°C

FLEX7 SINGLE SOCKET OUTLET (CABLE MOUNT) DIMENSIONS

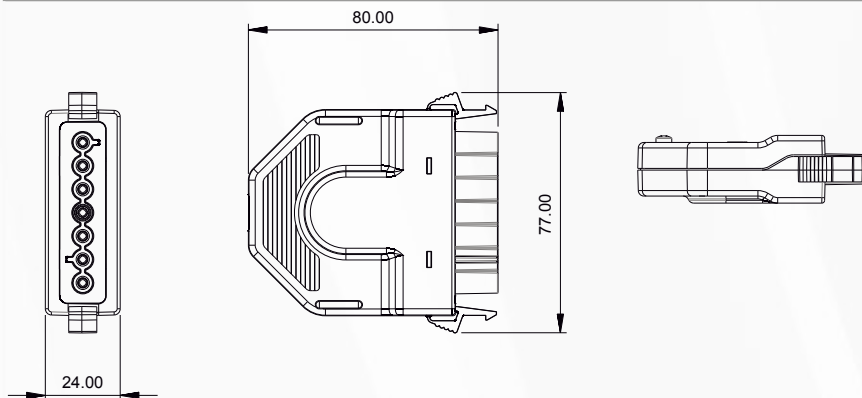

FLEX7 SINGLE SOCKET OUTLET (CABLE MOUNT)

SUPPLY VOLTAGE:	230V~
CURRENT RATING:	16A
FREQUENCY:	50Hz
TERMINAL CAPACITY:	0.50mm ² to 2.50mm ²
CORD GRIP CAPACITY:	11.50mm ² Ø
MATERIAL SPECIFICATION (MOULDED):	PA6, Halogen Free, UL94, V0
INGRESS PROTECTION:	IP2X
OPERATING TEMPERATURE RANGE:	-5°C / +40°C

FLEX7 DOUBLE SOCKET OUTLET (CABLE MOUNT) DIMENSIONS

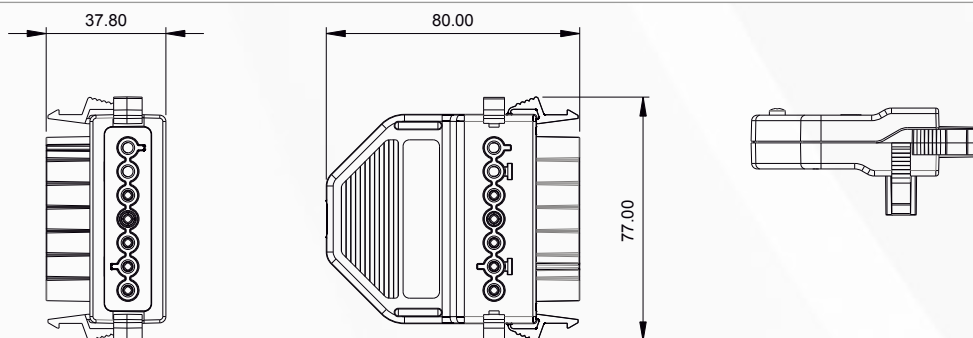

FLEX7 DOUBLE SOCKET OUTLET (CABLE MOUNT)

SUPPLY VOLTAGE:	230V~
CURRENT RATING:	16A
FREQUENCY:	50Hz
TERMINAL CAPACITY:	0.50mm ² to 2.50mm ²
CORD GRIP CAPACITY:	11.50mm ² Ø
MATERIAL SPECIFICATION (MOULDED):	PA6, Halogen Free, UL94, V0
INGRESS PROTECTION:	IP2X
OPERATING TEMPERATURE RANGE:	-5°C / +40°C

LOW SMOKE HALOGEN FREE (LSHF) FLEXIBLE CABLE

RATED VOLTAGE:	300V / 500V
CONDUCTOR SPECIFICATION:	Class 5, Copper to EN 60228
CONDUCTOR INSULATION:	Low Smoke Halogen Free (TI6)
SHEATH/JACKET INSULATION:	Low Smoke Halogen Free (TM7)
CONFORMANCE:	3-5 Core: BS EN 50525-3-11, H05Z1Z1-F 2-Core & 6-7 CORE: BS EN 50525-3-11 (construction, testing & performance although standard only caters for 3-5 core products), 05Z1Z1-F CPR (System 1+) - Cca s1b, d1, a1

LOW SMOKE HALOGEN FREE CABLE CONDUCTOR COLOURS

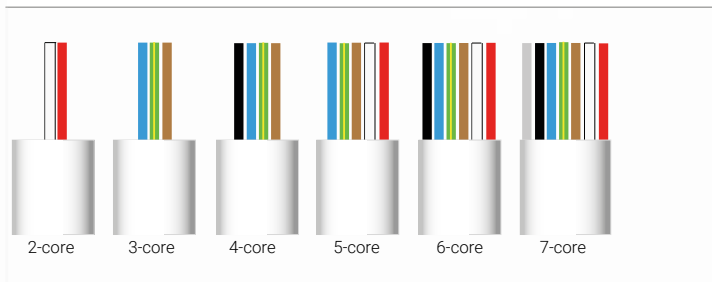

FLEX7 CONTROL MODULE DIMENSIONS

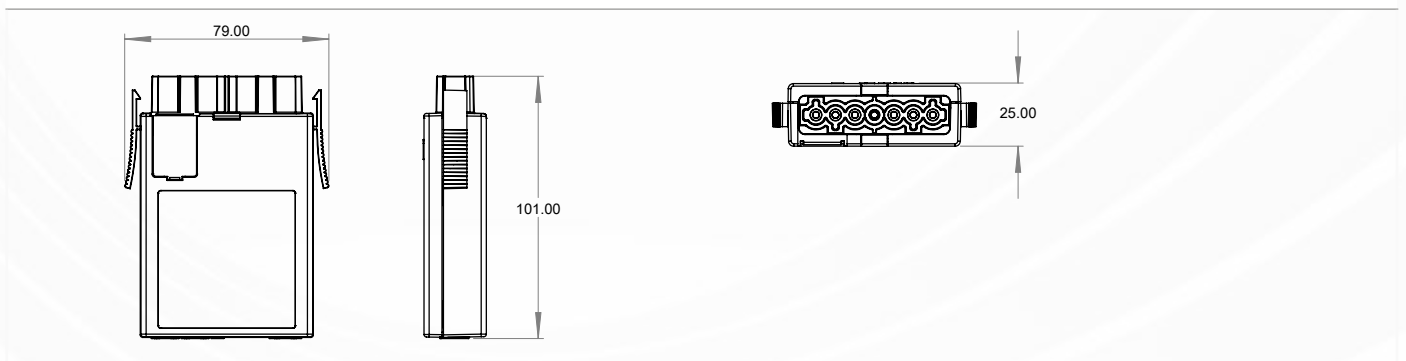

FLEX7 CONTROL MODULE

SUPPLY VOLTAGE:	230V~
CURRENT RATING:	6A
FREQUENCY	50Hz
MATERIAL SPECIFICATION (MOULDED):	PA6, Halogen Free, UL94, V0
INGRESS PROTECTION:	IP2X
OPERATING TEMPERATURE RANGE:	-5°C / +40°C

RELAY INRUSH

MAIN RELAY

EMERGENCY RELAY

MAX. LOAD:	6A	6A
MAX INRUSH:	120A for 20ms	120A for 20ms

FLEX7 STANDARD PIR SENSOR HEAD DIMENSIONS

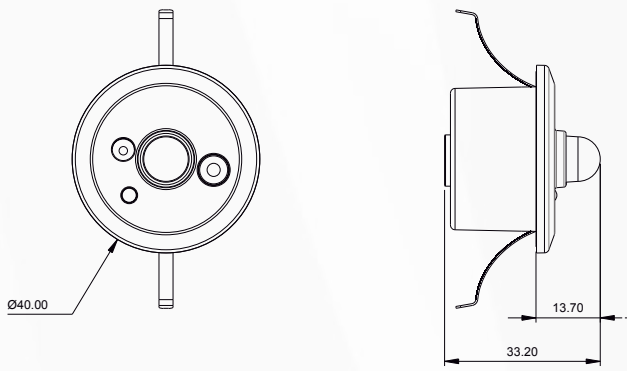

FLEX7 SURFACE MOUNT PIR SENSOR HEAD DIMENSIONS

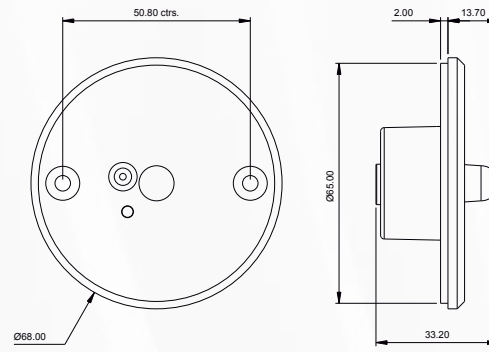

FLEX7 IP67 PIR SENSOR HEAD DIMENSIONS

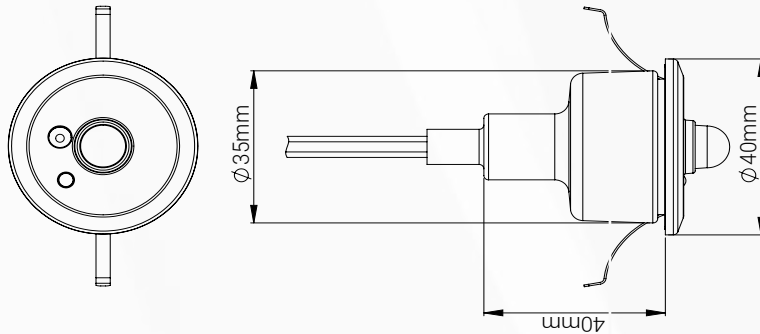

FLEX7 PIR SENSOR HEAD

SUPPLY VOLTAGE:	12V= (via flex7 Control Module/ZoneLite)
DETECTION RANGE:	9m x 7m when ceiling mounted 2.5m high
MATERIAL SPECIFICATION (MOULDED):	PA6, Halogen Free, UL94, V0
INGRESS PROTECTION:	IP2X & IP67
OPERATING TEMPERATURE RANGE:	-5°C / +40°C

FLEX7 12V MICROWAVE SENSOR HEAD DIMENSIONS

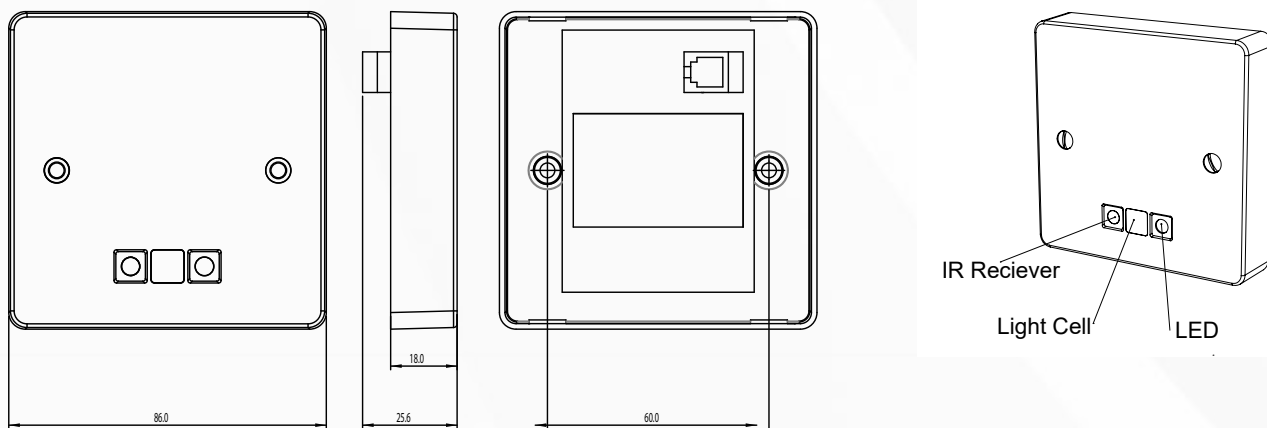

FLEX7 12V MICROWAVE SENSOR HEAD

SUPPLY VOLTAGE:	12V= (via flex7 Control Module/ZoneLite)
DETECTION RANGE:	25m x 6m when wall mounted 2.2m high 11m x 8m when ceiling mounted 2.5m high
MATERIAL SPECIFICATION (MOULDED):	PA6, Halogen Free, UL94, V0
INGRESS PROTECTION:	IP2X
OPERATING TEMPERATURE RANGE:	-5°C / +40°C

FLEX7 230V MICROWAVE SENSOR HEAD DIMENSIONS

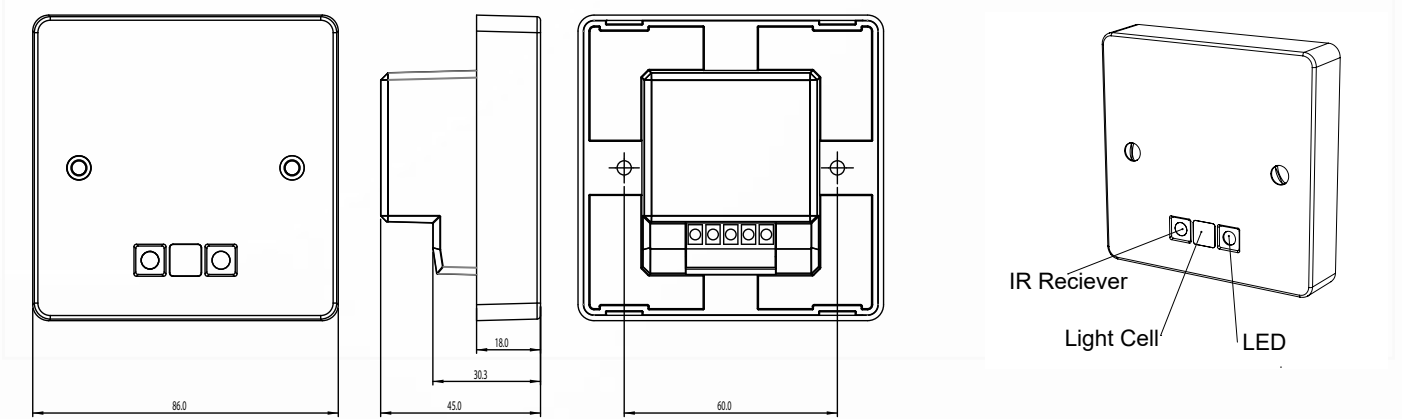

FLEX7 230V MICROWAVE SENSOR HEAD

SUPPLY VOLTAGE:	230V~
DETECTION RANGE:	25m x 6m when wall mounted 2.2m high 11m x 8m when ceiling mounted 2.5m high
MATERIAL SPECIFICATION (MOULDED):	PA6, Halogen Free, UL94, V0
INGRESS PROTECTION:	IP2X
OPERATING TEMPERATURE RANGE:	-5°C / +40°C

FLEX7 SWITCH DIMENSIONS

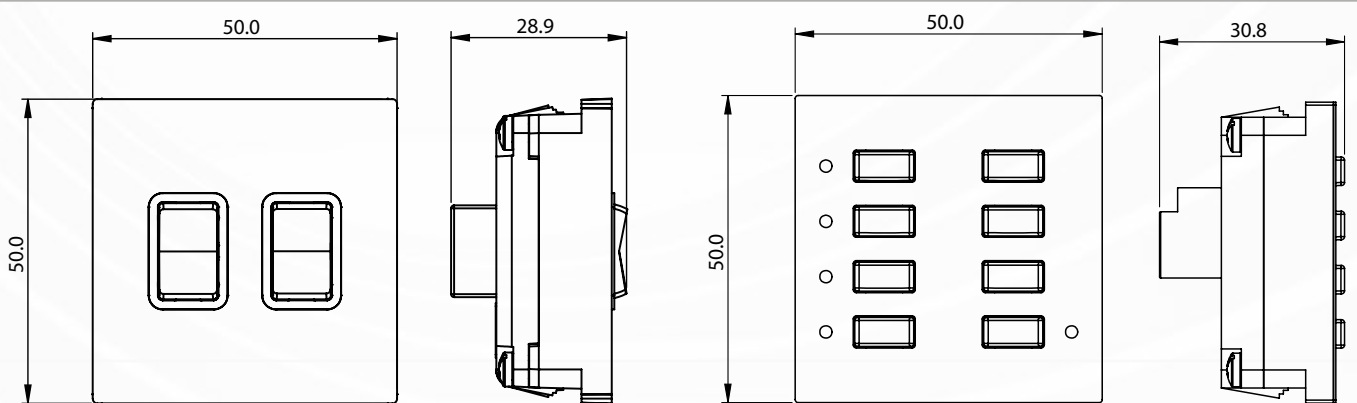

FLEX7 SWITCH

SUPPLY VOLTAGE:	5V= (via flex7 Control Module/ZoneLite)
MATERIAL SPECIFICATION (MOULDED):	PA6, Halogen Free, UL94, V0
INGRESS PROTECTION:	IP2X
OPERATING TEMPERATURE RANGE:	-5°C / +40°C

FLEX7 ZONELITE MODULE DIMENSIONS

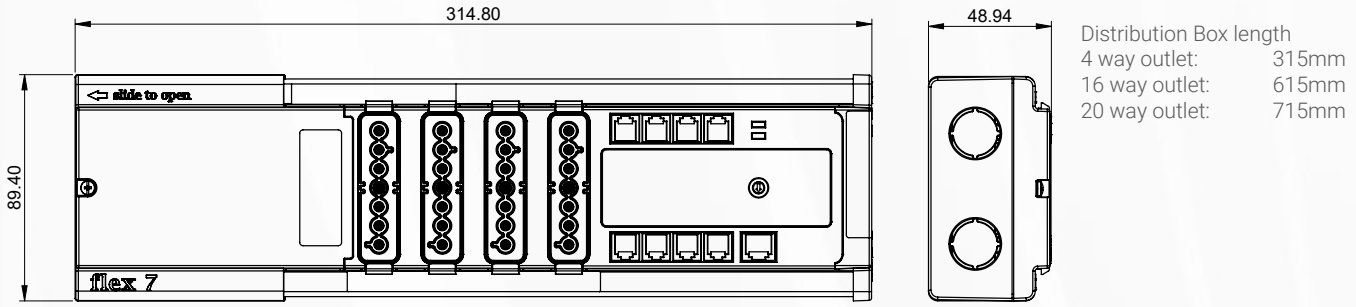

FLEX7 ZONELITE MODULE

SUPPLY VOLTAGE:	230V~
CURRENT RATING PER CHANNEL:	6A (16A maximum)
CURRENT RATING:	16A
FREQUENCY:	50Hz
TERMINAL CAPACITY (SOCKET):	5 x 1.50mm ² , 3 x 2.50mm ² conductors, 2 x 4.00mm ² or 1 x 6.0mm ²
CABLE ENTRY (KNOCKOUT):	4 x 20mm Ø (sides) 1 x 25mm Ø (rear)
MATERIAL SPECIFICATION:	PA6, Halogen Free, UL94, V0
INGRESS PROTECTION:	IP2X
OPERATING TEMPERATURE RANGE:	-5°C / +40°C

FLEX7 SCENE SET PLATE DIMENSIONS

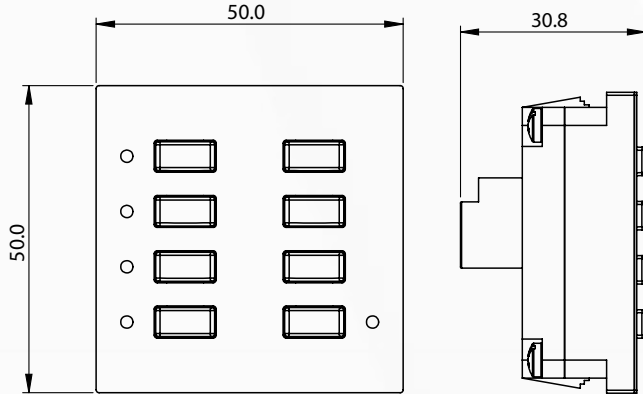

FLEX7 SCENE SET PLATE

SUPPLY VOLTAGE:	12V= (via ZoneLite)
MATERIAL SPECIFICATION (MOULDED):	PA6, Halogen Free, UL94, V0
INGRESS PROTECTION:	IP2X
OPERATING TEMPERATURE RANGE:	-5°C / +40°C





flex7 Ltd

Ruscombe Business Park

Ruscombe Lane

Twyford RG10 9JW

Tel: 020 8580 1066

www.flex7.co.uk info@flex7.co.uk